

ESCAPE FITNESS.

YOUR ESSENTIAL GUIDE TO
FUNCTIONAL TRAINING.

**ESCAPE
YOUR
LIMITS.**

CONTRIBUTORS.

EDITORIAL.

Matthew Januszek
and Ritchie Januszek.

ART DIRECTION.

Matthew Januszek.

DESIGN, PRODUCTION AND PHOTOGRAPHY.

Catherine McCulloch,
Tony Rogers, John Owen
and Elizabeth Morgan.

MODELS.

Ashley Moore

Anna Churakova

Lee Constantinou

Harry Crook

Darren Fox

Danni Levy

George-Anthony Dulal - Whiteway

Sarita Piotrowski

Sandra Radav

Christina Silva

Max Smith

Jasmine Takacs

Lisa Welham

Scott Clarke

Robert McStay

Randall Pich

Ritchie Januszek

Jessa Sparacino

Gabriella Moriarty



ESCAPE FITNESS EST. 1998.

TWO PASSIONS. ONE ETHOS.

With over 20 years' experience in the fitness industry, Escape Fitness has been at the forefront of functional fitness innovation, product design and rethinking modernised gym layouts to boost engagement and enhance the member experience.

The Escape story began with Richard Januszek, born in the UK just after World War II to Polish parents. An engineer by trade, Richard had a passion for designing products with a simple goal; to make things better.

At 15, Richard's eldest son Matthew, who was inspired by Arnold Schwarzenegger, started to lift weights. To encourage this interest, for Christmas in 1986, Richard converted part of the family garage into a gym.

Ever the innovator, Richard returned from work with a set of shiny stainless-steel bars featuring rotating handles to form what was probably the first dumbbell design to incorporate rotation handles. Following in his father's footsteps, Matthew recycled some old school desks to create a squat stand and bench for the garage gym.

These early ideas and innovations were just the start of what grew to become a hugely successful family business.

Escape Fitness is about partnerships, not meaningless business transactions. It's about building rapport with customers so they become a part of the family, helping shape ideas into a reality through experience, knowledge, innovative equipment, leading programming and expert training.

Two passionate people, one ethos – Escape Fitness – taking the ordinary, and making it extraordinary.

CONTENTS.



70



54



112



12

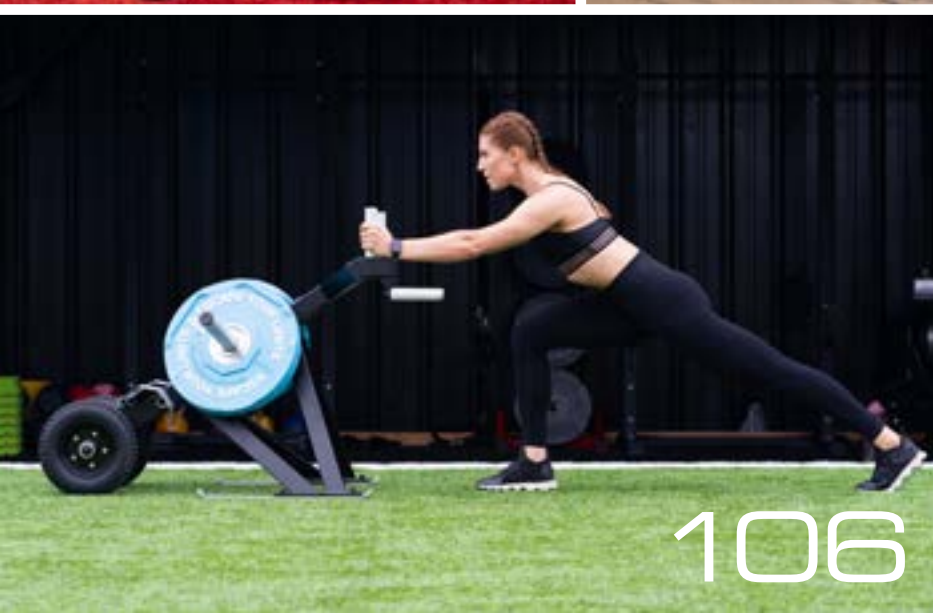

106



18

DIGITAL	06
STRENGTH	16
OCTAGON	60
FUNCTIONAL	104
BOXING	140
FLEXIBILITY	148
FLOORING	164
TRAINING	174
BEFORE YOU ORDER	186
TERMS AND CONDITIONS	188
WARRANTIES	191

DELIVERING AN OUTSTANDING TRAINING SPACE.

Escape Fitness is a global leader in functional fitness. Through the design of performance-driven training environments, development of innovative equipment, engaging programming and trainer education, Escape pushes the boundaries of what is possible and strives to make the ordinary, extraordinary.



CONCEPT TO COMPLETION.

Not all functional training spaces are created equal. To future-proof a functional environment requires expertise, knowledge and meticulous execution. Over the years, we have identified 7 key steps to success. These are outlined at the side of this page.

OUTSTANDING TRAINING SPACES.

Every Escape solution is custom-designed to optimise its space and provide an inspirational experience for both trainers and members. Our team creates functional playgrounds, indoors and outdoors, in dedicated spaces or as an integration into existing facilities.



DRIVING COMMUNITY.

Functional training can bring people together, and this sense of community is what keeps many people exercising. We create the perfect mix using the flexibility of the training style and the adaptability of our equipment to enable all abilities to train together.

PLANNING YOUR NEW FUNCTIONAL TRAINING SPACE?

Discover how to achieve the launch of an outstanding functional training experience.



SCAN FOR MORE INFORMATION.

SEVEN STEPS TO SUCCESS IN YOUR SPACE.

STEP 1.

A VISION FOR THE CLUB.

A vision is most of all about understanding your customers. Who do you want to appeal to? What are their fitness and social goals from using a facility? What kind of experience will attract these people? Making firm decisions about your preferred customer profiles and how best to meet their needs enables you to provide unique, personalised experiences.

STEP 2.

EQUIPMENT THAT MEETS YOUR MEMBERS' NEEDS.

With a clear vision in place, it's time to choose suitable equipment. Variety is the key to engaging experiences and functional training equipment delivers, with dozens of options available. But don't become blinded by what's on offer: remain true to your vision and select equipment perfectly suited to your chosen member profiles.

STEP 3.

A BRILLIANT TRAINING ENVIRONMENT.

Boutiques have proven that the environment in which people train is an integral part of the overall experience. It's about great aesthetics – colour schemes, lighting, wall graphics and so on – but it doesn't end there. Having a layout that works, suitable flooring and space-efficient equipment racks also contribute.

STEP 4.

KNOWLEDGEABLE, SKILLED AND CONFIDENT TRAINERS.

Functional equipment and free weights do not have on/off switches and they are not always intuitive to use. A club's trainers therefore need the knowledge to help members use the equipment safely and effectively. Add in the confidence to interact with members to form a sense of community and belonging, and you have a recipe for success.

STEP 5.

PROGRAMMING THAT EXCITES MEMBERS.

Most boutiques build their business around their programs, with each one having its own branding to communicate the experience and results members can expect. Without brilliant programming, there's a real danger that members will fail to get on board with functional training. Great programming teaches people how to use the equipment, brings them together for awesome social experiences, and delivers results over the long-term.

STEP 6.

A BUZZ ABOUT WHAT YOU DO.

Once the equipment, environment, trainers and programming are in place, it's time to tell the world. This starts with making sure that all of the club's staff (training and non-training) understand the key points about the equipment and programming. That's the starting point for communicating a clear message and generating word of mouth. Then it's about using online tools to spread the word more widely.

STEP 7.

CONSTANT EVOLUTION TO REMAIN ATTRACTIVE AND COMPETITIVE.

Offering the same experience for months on end can become tiresome and ultimately drive members into the door of a competitor. Boredom should not be an option in any fitness space. This is why regularly reviewing what you're offering is so important, coupled of course with an evolving experience that maintains the excitement and engagement.

THE ESCAPE YOUR LIMITS PODCAST.

The Escape Your Limits podcast is a weekly free audio and video release that reveals the mental, physical and emotional ingredients involved in standing out above everybody else.

Every episode enables a hungry audience to discover why successful people keep going when most people stop, and what keeps them going day after day. It's not about shortcuts for dreamers; these people prove that constant hard work Fueled by the right frame of mind is what makes dreams a reality. With Escape Your Limits, we can all learn from specific, actionable experiences and entrepreneurs can share how to make success happen for anyone.



SCAN FOR MORE INFORMATION.

THE WORKOUT APP.





Now there's support for anyone working out with Escape's functional training equipment – in the gym, outdoors, at work or at home.



SCAN FOR MORE INFORMATION.



THE GUESTS.

LEE HANEY - EP.47				
JIM STOPPANI - EP.65			EP.122	EP.284
HARLEY PASTERNAK - EP.83				
FRANK ZANE - EP.94				
STEPHANIE ESTIMA - EP.194				
NICK MITCHELL - EP.122				
ASHLEY JAMES - EP.147				
ALEX HORMOZI - EP.154				
GABRIELLE LYON - EP.159				
OLIVER PATRICK - EP.269				
COREY CALLIET - EP.284				
MARTYN FORD - EP.295				
FLEX LEWIS - EP.296				
BILLY BLANKS - EP.297				
BRET CONTRERAS - EP.229				
	EP.47	EP.94	EP.194	EP.229
	EP.269	EP.154	EP.147	EP.297

 LISTEN ON ITUNES  WATCH ON YOUTUBE



The workout app provides a pocket-sized training partner showcasing the best Escape products, and how to use them, at just the touch of a button.

Discover new ways to exercise using Escape equipment, with a few selected exercises for each item. Follow singles exercises, or take on a full workout to target strength, conditioning or total body benefits.

Available as a free download from the Apple and Android app stores.

FEATURES.

Exercise content is performed by Escape trainers and feature a wide range of functional tools including Corebags, Sandbags, Multi Grip Medballs, Bulgarian Bags, CMTs, GRIPRs, Plyosoft Boxes, Kettlebells, Bars and Plates, VERTBALLS, Battle Ropes, STRONGBOX and TIYR are all included.

MARS 2.0 WORKOUT SCREENS.

Meet MARS (Multi-Activity Resource Station), the next generation of digital coaching. MARS breaks down barriers to participation for those that feel unsure of how to use functional equipment safely and effectively. Combining first-class education on all our equipment with innovative equipment, our range of MARS screens create an inclusive virtual coaching environment that everyone can enjoy on every visit.

**NOT KNOWING
WHERE TO START
IN THE GYM PUT
EXERCISERS OFF
WITH OVER 29%
SAYING NOT KNOWING
HOW TO USE
EQUIPMENT MADE
THEM FEEL
UNCOMFORTABLE.**

(GYM GROUPS ONEPOLL 2022 SURVEY)



FUNCTIONAL PACK.

Offer any time access to high quality quick and easy to access exercise and equipment instruction through a vibrant touchscreen. Unlock a huge selection of engaging fitness content from over 600 individual exercises, 25 different pieces of equipment to over 45 full-on workouts.

Switch on and switch off content to create a resource library that mirrors the equipment available in your facility, delivering a highly bespoke workout experience for every user.

PACK INCLUDES:

MARS 31.5" screen mounted between 2x RACK5s with 1x 65cm Steadyball, 1x 75cm Steadyball, 3x Rollers, 8x Studio Kettlebells 4/8/12/16kg (two of each), 2x Corebags 5/10kg (one of each), 2x Medicine Balls 6/7kg (one of each), 8x STAKRBELLS 4x 2kg 4x 3kg (2 Sets), 5x GRIPRS 2/4/6/8/10kg (one of each), 3x CMT 1/2/4kg (one of each), 1x DECK 2.0 and 4x Core Mats.

MARSRACK5 MARS RACK5 Equipment Pack

SPECIFICATIONS:

SCREEN: Size: 76cm (h) x 46cm (w) x 0.5cm (d).

Weight: 12kg.

RACK: Size: 185.6cm (h) x 185cm (w) x 70cm (d).
Weight: 75kg.



FUNCTIONAL SCREEN.

Experience vibrant visuals with the MARS 2.0 Functional Screen. Every exercise and workout video is brought to life, ensuring an immersive viewing experience that captivates the user and provides a seamless and intuitive workout experience.

With regular content updates, the MARS 2.0 Functional screen has the back of every user on every visit, enabling operators to provide a safe, supportive experience regardless of goals or ability.

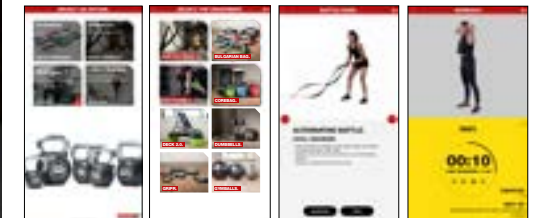

MARS2 MARS 31.5" High-definition Android operated touchscreen with 3 year licence for software and 3 year warranty. Mountable on a frame, rack or wall.

SPECIFICATIONS:

SCREEN: Size: 76cm (h) x 46cm (w) x 0.5cm (d). Weight: 12kg.

Speak to your representative about 5 year content licence.

STRENGTH PACK.

With a small footprint, the MARS Strength Station delivers a fully coached, self-contained, total body training solution designed to complement any training facility.

Jam packed with dumbbell-driven exercises and workouts, creating an always available safe and effective support service.

Every exercise is brought to life by a video demonstration and training tips to help users optimize each and every rep. Couple this advanced coaching aid with Escape's unique space-saving XRACK with Nucleus Dumbbells and say hello to the next generation strength training pod.

PACK INCLUDES:
 MARS 21.5" screen mounted onto an XRACK with either Nucleus Urethane Dumbbell Set 1-10kg in 1kg incs (10 pairs - 20 total) with XRACK2 or Nucleus Urethane Dumbbell Set 2-20kg in 2kg incs (10 pairs - 20 total) with XRACK2



STRSTA110P MARS Strength Pack - 1-10kg
STRSTA220P MARS Strength Pack - 2-20kg

SPECIFICATIONS:

SCREEN: Size: 54cm (h) x 33cm (w) x 5cm (d).
 Weight: 4.7kg.
XRACK: Size: 154.5cm (h) x 76cm (w) 70cm (d).
 Weight: 54kg.

STRENGTH SCREEN.

Introducing the MARS Strength touchscreen, revolutionising user interaction with its advanced interface. Delivering vivid and detailed visuals, MARS Strength emphasises both innovation and reliability. Backed by a commitment to quality it ensures seamless and engaging user experience.



MARS215 MARS 21.5" High-definition Android operated touchscreen with 3 year licence for software and 3 year warranty. Mountable on a XRACK or wall.

SPECIFICATIONS:
SCREEN: Size: 54cm (h) x 33cm (w) x 5cm (d). Weight: 4.7kg.

Speak to your representative about 5 year content licence.

RECOVERY PACK.

A full active recovery station, warm-up, and mobility pack, which combines Escape's revolutionary MARS screen and Hyperice's Hypervolt Pro 2 percussion massage device. Integrating education and coaching via digital content provides virtual, one to one, coaching, 24 hours a day, empowering athletes of all abilities to use the equipment and technology safely and effectively.

21.5" TOUCHSCREEN.

MAT RACK HOLDER.

BRACKET FOR TETHERED HYPERVOLT GUN.

PACK INCLUDES:

MARS 21.5" screen mounted onto a RACK5 with Hypervolt Pro2 (bracket included),
1x 65cm Steadyball,
1x 1kg CMT, 1x Yoga Block,
1x Ridge Roller,
1x Core Mat, 1x Yoga Mat.

MOBSTA MARS Recovery Pack

SPECIFICATIONS:

SCREEN: Size: 54cm (h) x 33cm (w) x 5cm (d).
Weight: 4.7kg.

RACK5: Size: 189.6cm (h) x 69.9cm (w) x 60cm (d).
Weight: 75kg.



STRENGTH.

The strength range stands out from the crowd, with options accessible to all abilities and a durability to withstand the toughest of strength sessions.

Its functionality, considered design and performance sets it apart, and helps your members achieve their goals. With complimentary pieces that complete sets, this range is fit for purpose, durable and practical, seamlessly integrating for a whole strength solution and big lifting experience.



DUMBBELLS	20
STORAGE RACKS AND SETS	26
BARBELLS	32
KETTLEBELLS	34
PLATES	40
EVERGREEN ECO REP SET	46
BARS AND COLLARS	48
LIFT PLATFORMS	50
BASE STATION	53
BENCHES	54



FREE WEIGHTS - AT THE CORE OF WHAT WE DO.

Functional and strength training has been at the core of our mission and workout philosophy since we embarked on this journey over 25 years ago.

We took a simple resistance training tool, built by my father when I was a teenager, and this became the central idea for our family business start-up, the formation of Escape Fitness and becoming the first company to develop an affordable SBX dumbbell for the UK fitness industry.

Having saved up to import into the UK, we hit our lucky break when a small start-up reached out to us with a problem; they had been let down by their supplier and urgently needed a set of dumbbells for their grand opening the next morning. Presented with the opportunity, we delivered that very same evening.

That small start-up went on to become one of the biggest fitness chains in Europe, and in turn, helped us to become one of the largest suppliers of commercial free weights in the world. Over 1100 tonnes shipped in the last 12 months alone proves that when you invest in an Escape product, you can guarantee your investment is in safe hands.

More than two decades later, we continue to solve problems for our customers and to design and build high quality functional free weight training equipment.

As one of the few fitness companies to own a dedicated manufacturing facility, we produce patented dumbbells and weight plates with complete control of the supply chain, from raw materials to shipping cartons. With no middle men, no trading agents and no additional costs built in, you can be assured you're getting the best possible price and quality on the market.

Matthew Januszek

DUMBBELLS AND BARBELLS.

A pair, or set of dumbbells or barbells is an essential for any fitness goal or training space. To ensure users reap the full benefits of reps and sets, our materials have evolved over years using a special formula and a rigorous testing protocol to ensure we can boast the best on the market, setting a new benchmark for quality. Your investment is manufactured to the highest standards, and seamlessly integrates dumbbells and barbells with our racks and storage solutions, ensuring long-lasting craftsmanship and user satisfaction.



COMPARISON CHART.

FEATURES.	URETHANE DUMBBELLS.	SBX DUMBBELLS.	STAKRBELL.
USE	Free weight areas for strength training with increased versatility.	Free weight areas for strength training and traditional workouts.	Group Exercise, Studio or Consumer.
HEAD MATERIAL	Urethane	SBX	Cast Iron and Polyurethane
HANDLE	Hard Satin Chrome	Hard Satin Chrome	Ergonomically designed, polyurethane coated
LOCKING	Dual-lock plus	Dual-lock plus	-
WEIGHTS	1kg – 10kg (1kg increments) 12kg – 50kg (2kg increments)	2.5kg-50kg (2.5kg increments)	2kg - 3kg (can be stacked up to 10kg)
WARRANTY	5 years	3 years	1 year

HOW TO CHOOSE.



URETHANE DUMBBELLS.

Durable to match the demands of high-use facilities, these dumbbells have a permanently-bonded, steelhead and dual lock construction. Featuring weight indications on top and on the sides, the unique head shape, round at the front face to an Octagon at the rear, gives the parallel faces for anti-roll benefits.

SBX DUMBBELLS.

The SBX dumbbells don't extend as high in weight range but still feature the same patented "Dual Lock Plus" process, hard satin chrome, splined press fit at three tonnes and are full penetration welded. In contrast to the urethane range, the SBX dumbbells cater more for low-to-medium use facilities.



STAKRBELL.

The STAKRBELL has a unique, flat design for space-saving efficiency, perfect of commercial or at-home use. The stackable weight options create an array of options whilst the non-roll design means these dumbbells will always remain where you place them.



URETHANE DUMBBELLS.

With a permanently-bonded, steelhead and dual lock construction, this innovative dumbbell range even features weight indications moulded into top and sides of the weights. Seamlessly integrates with our Rigid Rack storage solutions.

TOP-DOWN NUMBERING.

Weight indicators visible from your take off and grip positions.

GRIP.

Premium textures for squat and swing grip variation.

HANDLES.

Salt spray tested chrome handles.

NUMBERING.

Oversized numbering for fast weight identification.

EVOLUTION EDGING.

Circle-to-octagon shaping inspires anti-roll confidence.



PUDB110	1-10kg	Urethane Dumbbell Set 1kg incs (10 pairs – 20 total)
PUDB220	2-20kg	Urethane Dumbbell Set 2kg incs (10 pairs – 20 total)
PUDB2230	22-30kg	Urethane Dumbbell Set 2kg incs (5 pairs – 10 total)
PUDB3240	32-40kg	Urethane Dumbbell Set 2kg incs (5 pairs, 10 total)
PUDB4250	42-50kg	Urethane Dumbbell Set 2kg incs (5 pairs, 10 total)
PUDB420	4-20kg	Urethane Dumbbell Set 4kg incs (5 pairs, 10 total)

RACK SPECIFICATIONS.

RACKDB10 10 Pair Dumbbell Rack (as shown)
Holds 10 pairs (up to 20kg pairs) SBX or Urethane Dumbbells (20 total)
Size: 1964mm x 700mm x 755mm. Weight 60kg.



SBX DUMBBELLS.

These SBX dumbbells still feature the same patented “Dual Lock Plus” process, splined press fit at three tonnes and are full penetration welded making them durable and a cost effective alternative to the Urethane range.



STRENGTH.

RBDB2525	2.5-25kg	SBX Dumbbell Set 2.5kg incs (10 pairs – 20 total)
RBDB2750	27.5-50kg	SBX Dumbbell Set 2.5kg incs (10 pairs – 20 total)
RBDB1235	12.5-35kg	SBX Dumbbell Set 2.5kg incs (10 pairs – 20 total)
RBDB515	5-15kg	SBX Dumbbell Set 2.5kg incs (5 pairs – 10 total)
RBDB525	5-25kg	SBX Dumbbell Set 5kg incs (5 pairs, 10 total)

RACK SPECIFICATIONS.

RACKDB10 10 Pair Dumbbell Rack (as shown)
Holds 10 pairs (up to 20kg pairs) SBX or Urethane Dumbbells (20 total)
Size: 1964mm x 700mm x 755mm. Weight 60kg.



NUMBERING.

Oversized numbering for fast weight identification.

FIXING.

Patented fixing technology.

EVOLUTION EDGING.

Circle-to-octagon shaping inspires anti-roll confidence.



SCAN FOR MORE INFORMATION.

STAKRBELL.

The STAKRBELL has a unique, flat design for space-saving efficiency, perfect for commercial or at-home use. The stackable weight options create an array of options whilst the non-roll design means these dumbbells will always remain where you place them.

Pair STAKRBELL with either DECK 2.0 or Step Platform Solution to create a complete, independent workout station.

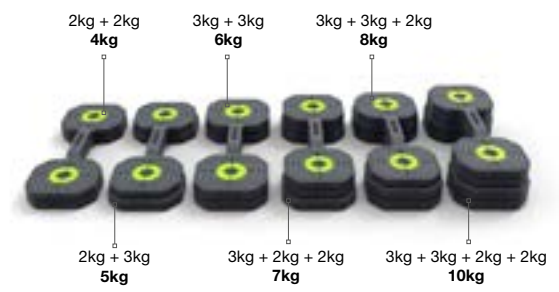
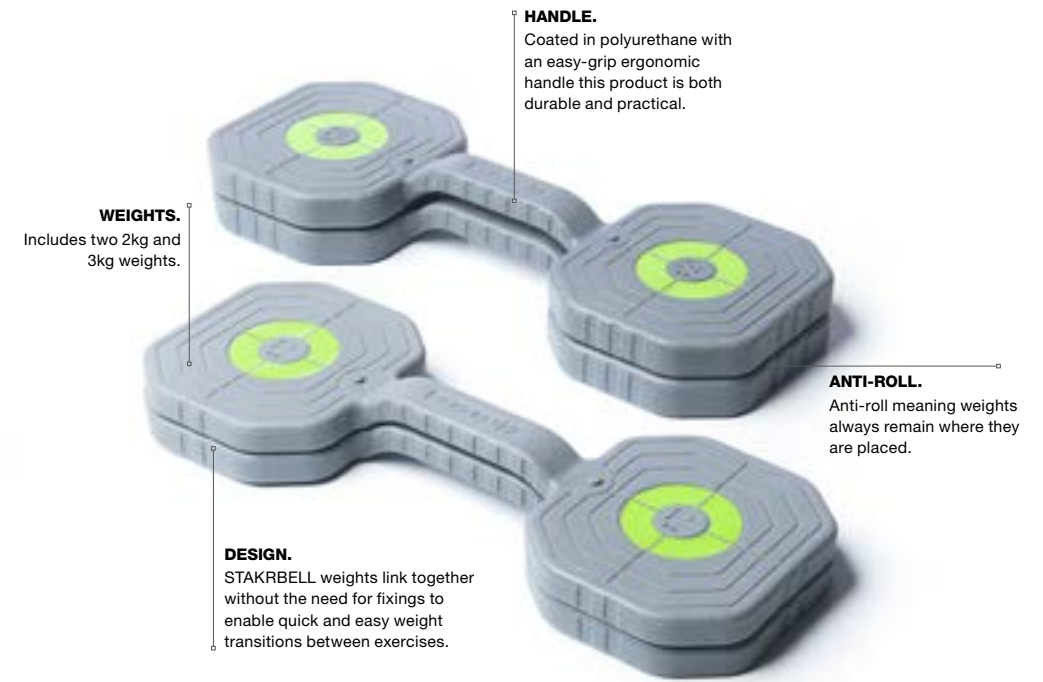

STORAGE.
The STAKRBELLS are designed to fit inside the integrated storage space in DECK 2.0 to create a space saving solution that keeps training spaces free of clutter.



STAKR23 STAKRBELL 2kg and 3kg
x2 2kg - 352.5mm (L) x 128.5mm (D) x 26.5mm (H)
x2 3kg - 365mm (L) x 135mm (D) x 33.5mm (H)
Total weight per set 10kg

STRENGTH.

STORAGE RACKS.

Great storage maximises floorspace, opening the door to the best possible member experience. Faced with a fixed overhead of running a facility in terms of cost per square foot or square metre, freeing up as much space as possible for training is vital.

The Escape Rigid Rack range has been created to provide a slimmer, subtler storage option to ensure the right fit, whatever the need.

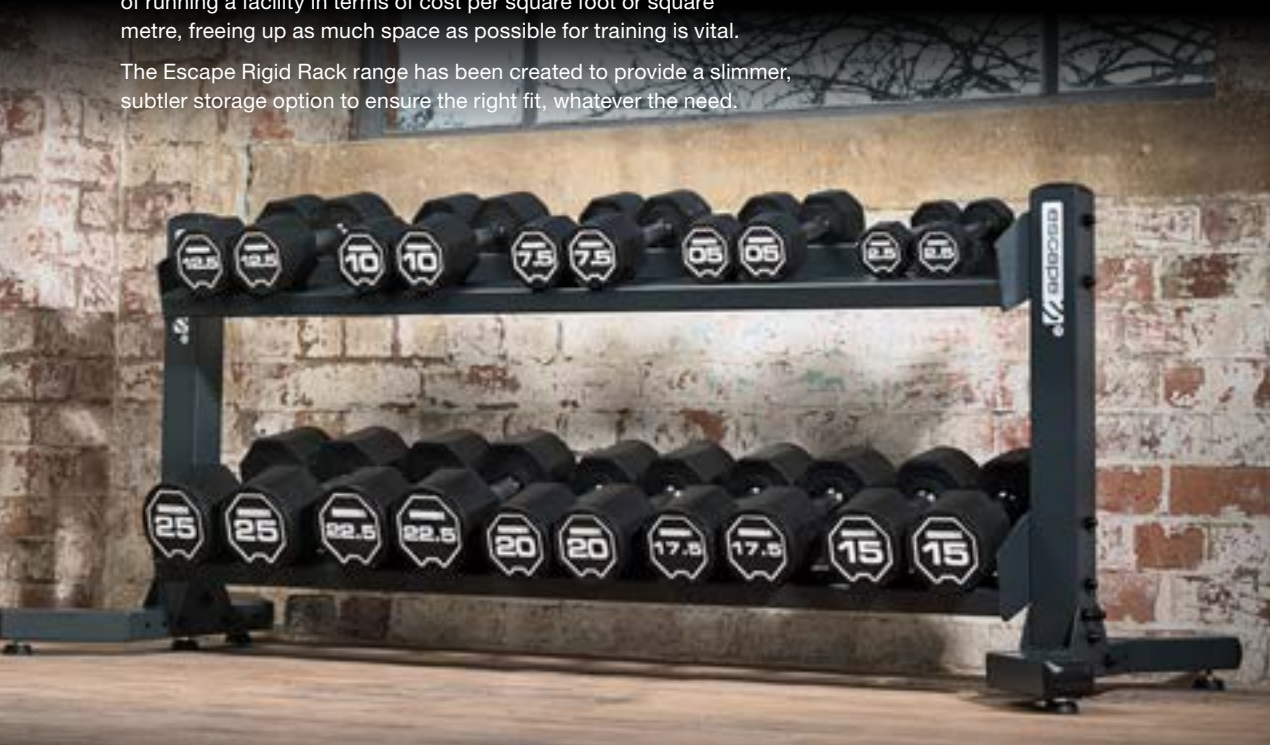

FEATURES.	VERTICAL RACK.	XRACK 2.0.	RIGID RACKS.
MATERIAL	Carbon Steel	Carbon Steel	Carbon Steel
SIZE	W: 700mm x D: 700mm x H: 1736mm.	W: 760mm x D: 700mm x H: 1545mm.	10 Pair Rack W: 1964mm x D: 700mm x H: 755mm. 15 Pair Rack W: 1964mm x D: 700mm x H: 1147mm.
WEIGHT	33kg	54kg	10 Pair Rack - 60kg 15 Pair Rack - 80kg
HOLDS	Holds 20 Dumbbells (10 pairs up to a maximum weight of 20kg).	Holds 20 Dumbbells (10 pairs up to a maximum weight of 20kg).	10 Pair Rack (Holds 10 pairs 20 total) 15 Pair Rack (Holds 15 pairs 30 total)
WARRANTY	2 Years	5 Years	2 Years

HOW TO CHOOSE.



VERTICAL RACK.

The Vertical Dumbbell Rack conveniently organises your Escape dumbbells and delivers a space-saving alternative to a horizontal rack.



XRACK 2.0.

With a striking look and improved space efficiency, the XRACK adds angular style and practicality to any facility.



RIGID RACKS.

The Rigid Racks are designed to be a lighter weight, more discreet and slimline rack option to minimise both material and cost.

STRENGTH.

DUMBBELL SETS WITH VERTICAL RACK.

Combine your dumbbell set with the Vertical Dumbbell Rack which conveniently organises your Escape dumbbells and delivers a space-saving alternative to a horizontal rack. Providing easy accessibility, it maximises floor space with minimal fuss.



URETHANE DUMBBELL SETS WITH VERTICAL RACK.

PADB110V	1-10kg	Urethane Dumbbell Set RACKVDB 1kg incs (10 pairs – 20 total)
PADB220V	2-20kg	Urethane Dumbbell Set RACKVDB 1kg incs (10 pairs – 20 total)

SBX DUMBBELL SETS WITH VERTICAL RACK.

RBDB2525V	2.5-25kg	SBX Dumbbell Set RACKVDB 2.5kg incs (10 pairs – 20 total)
------------------	----------	--

RACK SPECIFICATIONS.

RACKVDB	Vertical Dumbbell Rack (as shown) Holds 20 Dumbbells (10 pairs up to a maximum weight of 20kg). Size: 700mm x 700mm x 1736mm. Weight 33kg.
----------------	--

DUMBBELL SETS WITH XRACK 2.0.

Add angular style and practicality to your dumbbell storage solution by opting to pair your dumbbell set with the bold XRACK 2.0. Maximise vertical storage options with style whilst still making a visual impact.



URETHANE DUMBBELL SETS WITH XRACK 2.0.

PADB110X	1-10kg	Urethane Dumbbell Set XRACK2 1kg incs (10 pairs – 20 total)
PADB220X	2-20kg	Urethane Dumbbell Set XRACK2 2kg incs (10 pairs – 20 total)

RACK SPECIFICATIONS.

XRACK2	XRACK 2.0 (as shown) Holds 20 Dumbbells (10 pairs up to a maximum weight of 20kg). Size: 760mm x 700mm x 1545mm. Weight 54kg
---------------	--

XRACK WITH MARS SCREEN.

The Strength Station combines Escape's unique space-saving XRACK with Nucleus Dumbbells with the digital coaching solution, MARS.

PACK INCLUDES:

MARS 21.5" screen mounted onto an XRACK with either Nucleus Urethane Dumbbell Set 1-10kg in 1kg incs (10 pairs – 20 total) with XRACK2 or Nucleus Urethane Dumbbell Set 2-20kg in 2kg incs (10 pairs – 20 total) with XRACK2

STRSTA110P MARS Strength Pack - 1-10kg
STRSTA220P MARS Strength Pack - 2-20kg

SPECIFICATIONS:

SCREEN: Size: 54cm (h) x 33cm (w) x 5cm (d).
 Weight: 4.7kg.

XRACK: Size: 154.5cm (h) x 76cm (w) 70cm (d).
 Weight: 54kg.



DUMBBELL SETS WITH RIGID RACK.

A cost-effective option for keeping members and equipment safe, this storage unit also gives you the ability to turn its feet inwards so that racks can be placed adjacent to each other.



URETHANE DUMBBELL SETS WITH RIGID RACK.

PUSB220R 2-20kg Urethane Dumbbell Set RACKDB10
 2kg incs (10 pairs – 20 total)
PUSB230R 2-30kg Urethane Dumbbell Set RACKDB15
 2kg incs (15 pairs – 30 total)
PUSB240R 2-40kg Urethane Dumbbell Set RACKDB10/15
 2kg incs (20 pairs – 40 total)

SBX DUMBBELL SETS WITH RIGID RACK.

RBBB2525R 2.5-25kg SBX Dumbbell Set RACKDB10
 2.5kg incs (10 pairs – 20 total)
RBBB2750R 27.5-50kg SBX Dumbbell Set RACKDB15
 2.5kg incs (10 pairs – 20 total)

RACK SPECIFICATIONS.

RACKDB10 10 Pair Dumbbell Rigid Rack (as shown)
 Size: 1964mm x 700mm x 755mm. Weight 60kg.
RACKDB15 15 Pair Dumbbell Rigid Rack
 Size: 1964mm x 700mm x 1147mm. Weight 80kg.

URETHANE BARBELLS.



FIXING.
Assembled with our unique patented "Dual Lock Plus" process.

EVOLUTION EDGING.
Circle-to-octagon shaping inspires anti-roll confidence.

KNURL.
Precise and defined knurl.

TOP DOWN NUMBERING.
Weight indicators visible from your take off and grip positions.

PUBB1020	10-20kg	Urethane Barbell Set 2.5kg incs (5 Barbells)
PUBB2545	25-45kg	Urethane Barbell Set 2.5kg incs (5 Barbells)
PUBB1045	10-45kg	Urethane Barbell Set 2.5kg incs (10 Barbells)

URETHANE CURL BARBELLS.

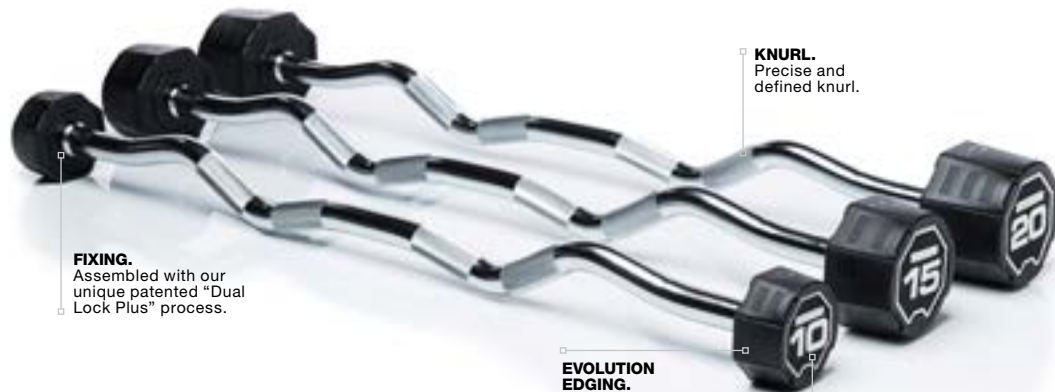

FIXING.
Assembled with our unique patented "Dual Lock Plus" process.

KNURL.
Precise and defined knurl.

EVOLUTION EDGING.
Circle-to-octagon shaping inspires anti-roll confidence.

TOP DOWN NUMBERING.
Weight indicators visible from your take off and grip positions.

PUCBB1020	10-20kg	Urethane Curl Barbell Set 2.5kg incs (5 Barbells)
PUCBB2545	25-45kg	Urethane Curl Barbell Set 2.5kg incs (5 Barbells)
PUCBB1045	10-45kg	Urethane Curl Barbell Set 2.5kg incs (10 Barbells)
PUMBB1020	10-20kg	Urethane Barbell & Curl Barbell Set 2.5kg incs (5 Barbells and 5 Curl Barbells)

URETHANE BARBELL SETS WITH RIGID RACK.



URETHANE BARBELL SETS WITH RACK.

PUBB1020R	10-20kg	Urethane Barbell Set RACKBB5 (5 Barbells)
PUBB2545R	25-45kg	Urethane Barbell Set RACKBB5 (5 Barbells)
PUBB1045R	10-45kg	Urethane Barbell Set RACKBB10 (10 Barbells)

URETHANE CURL BARBELL SETS WITH RACK.

PUCBB1020R	10-20kg	Urethane Curl Barbell Set RACKBB5 (5 Barbells)
PUCBB2545R	25-45kg	Urethane Curl Barbell Set RACKBB5 (5 Barbells)
PUCBB1045R	10-45kg	Urethane Curl Barbell Set RACKBB10 (10 Barbells)
PUMBB1020R	10-20kg	Nucleus Urethane & Curl Barbell Set RACKBB10

RACK SPECIFICATIONS.

RACKBB5	5 Barbell Rigid Rack (single sided) Size: 1168mm x 700mm x 1147mm. Weight 31kg.
RACKBB10	10 Barbell Rigid Rack (as shown) Size: 1168mm x 700mm x 1147mm. Weight 36kg.

STRENGTH.

KETTLEBELLS.

Escape's comprehensive range of kettlebells has an option to suit every workout intensity. From tough cross training gyms to chic, boutique PT studios, all our kettlebells incorporate the highest quality materials to ensure there's a perfect match for every member.



COMPARISON CHART.

FEATURES.	COMPETITION PRO KETTLEBELLS 2.0.	SBX KETTLEBELLS.	STUDIO KETTLEBELLS.
USE	Kettlebell sport lifting, cross training	Free weight areas for strength training and traditional workouts	Studio workouts, group training
BELL MATERIAL	Carbon steel with hollow core	Rubber covered cast iron core	Vinyl dip with a cast iron core
HANDLE	Cast stainless steel with a satin chrome finish	Hard satin chrome patented handle to bell connection	Cast iron
FEATURE	Powder coated and engraved weight indicators	Textures and grooves across the kettlebell allow for more dynamic grip options	Vinyl coating and colours
TOLERANCE	+/- 2%	+/- 2%	+/- 3%
WEIGHTS	8-32kg in 4kg increments	8kg-32kg in 4kg increments	4kg-20kg in 4kg increments
WARRANTY	2 years	3 years	1 year

COMPETITION PRO KETTLEBELLS 2.0.

The heavy-duty choice for clubs and members who take their lifting seriously. Uniform size and industry standard colour coding to meet competition standards. Cast stainless steel handles won't rust, and extra-tough powder coating with engraved weight indicators ensure life-long visibility.



STRENGTH.

SBX KETTLEBELLS.

The innovative SBX kettlebell range offers a high level of practicality that lasts. Textures and grooves allow for more grip options with dynamic feedback when shifting weight, while the hard satin chromed and salt tested handles ensure longevity.



STUDIO KETTLEBELLS.

Gentle on your grip as well as your flooring. The cast iron bell is vinyl dipped with bright colors so you can easily organise your collection by weight. Durable and versatile, these best-selling, effective weights start at 4kgs, making them a great entry-level option.



COMPETITION PRO KETTLEBELLS 2.0.



HOLLOW CORE.
Hollow core design that enables more of the weight to be distributed closer to the handle rather than the base.

BASE.
The wide, flat base is perfect for renegade rows and push-ups.

HANDLE.
Cast stainless steel handles that won't rust.

CKB208	8kg	Competition Pro Kettlebell 2.0 – Purple
CKB212	12kg	Competition Pro Kettlebell 2.0 – Blue
CKB216	16kg	Competition Pro Kettlebell 2.0 – Yellow
CKB220	20kg	Competition Pro Kettlebell 2.0 – Grey
CKB224	24kg	Competition Pro Kettlebell 2.0 – Green
CKB228	28kg	Competition Pro Kettlebell 2.0 – Orange
CKB232	32kg	Competition Pro Kettlebell 2.0 – Red
TRAIN03	Kettlebell Product Training Workshop	

SBX KETTLEBELLS.



GRIP.
360-degree grip and dynamic feedback.

SALT TESTED.
Hard satin chromed handles have been salt tested to last.

HANDLE.
Patented 'fish tail' welded into cast iron core bell.

NUMBERING.
Oversized numbering for fast weight identification.

LONGEVITY.
Hard-wearing, durable SBX coating designed to prevent damage to surfaces.

RBKB04	4kg	SBX Kettlebell
RBKB08	8kg	SBX Kettlebell
RBKB12	12kg	SBX Kettlebell
RBKB16	16kg	SBX Kettlebell
RBKB20	20kg	SBX Kettlebell
RBKB24	24kg	SBX Kettlebell
RBKB28	28kg	SBX Kettlebell
RBKB32	32kg	SBX Kettlebell
RBKB424	4-24kg	SBX Kettlebell Set (8 Kettlebells total)
TRAIN03	Kettlebell Product Training Workshop	
Kettlebells sold individually.		

COMPETITION KETTLEBELL SETS WITH RIGID RACK.

Maximise floor space with these cost-effective Rigid Racks. Made from affordable, lightweight steel with feet that can be turned inwards to stand rack units next to each other. Designed to be practical and discreet whilst minimising material and cost.



CKB8322R	8-32kg	x2 Competition Kettlebell Set RACKKB2 4kg incs (14 Kettlebells total)
-----------------	--------	---

TRAIN03 Kettlebell Product Training Workshop

RACK SPECIFICATIONS.

RACKKB2 Rigid Kettlebell Rack
Holds 14 Competition Kettlebells
Size: 1577mm x 700mm x 755mm. Weight 53kg.

Kettlebells sold individually.

SBX KETTLEBELL SETS WITH RIGID RACK.

The Kettlebell Rigid Rack is a 2-shelf rack option, the Rigid Rack efficiently tucks away against a flat surface, safely storing the kettlebells to free up the gym floor space.



RBKB4322R	4-32kg	SBX Kettlebell Set x2 RACKKB2 (as shown) (16 Kettlebells total)
------------------	--------	---

TRAIN03 Kettlebell Product Training Workshop

RACK SPECIFICATIONS.

RACKKB2 Rigid Kettlebell Rack
Holds 16 SBX Kettlebells
Size: 1577mm x 700mm x 755mm. Weight 53kg.

Kettlebells sold individually.

STUDIO KETTLEBELLS.

These durable Studio Kettlebells are gentle on your grip as well as your flooring. Exceptionally well-designed, the cast iron bell is vinyl dipped with bright colors so you can easily organise your collection by weight.



NUMBERING.
Oversized numbering for fast weight identification.

HANDLE.
Made to sit comfortably in the hand so members can concentrate on their workout.

PROTECTS.
Vinyl dip means studio floors will be protected.

LONG LASTING.
Cast Iron construction with a vinyl dip covering means these kettlebells will last longer.

- VKB04** 4kg Studio Vinyl Kettlebell - Green
- VKB08** 8kg Studio Vinyl Kettlebell - Blue
- VKB12** 12kg Studio Vinyl Kettlebell - Red
- VKB16** 16kg Studio Vinyl Kettlebell - Grey
- VKB20** 20kg Studio Vinyl Kettlebell - Black
- TRAIN03** Kettlebell Product Training Workshop

Kettlebells sold individually.

KETTLEBELL RACKS.

The Kettlebell Rigid Rack is a 2-shelf rack option, the Rigid Rack efficiently tucks away against a flat surface, safely storing the kettlebells to free up the gym floor space.



RACK SPECIFICATIONS.

RACKKB2 Rigid Kettlebell Rack
Holds up to 4 sets of 4-20kg
20 Studio Kettlebells (as shown on page 34)
Size: 1577mm x 700mm x 755mm. Weight 53kg.

DUMBBELL AND KETTLEBELL SETS WITH RIGID RACK.

Keep dumbbells and kettlebells stored safely but easily accessible with our racks. For the complete storage solution, we have selected some rack combinations based on our bestsellers.



- KB432PU220R** 2-20kg Urethane Dumbbells 2kg incs, (10 pairs, 20 total), 4-32kg SBX Kettlebell Set (8 Kettlebells total) RACKKD
- KB432RB225R** 2.5-25kg SBX Dumbbells 2.5kg incs, (10 pairs, 20 total), 4-32kg SBX Kettlebell Set (8 Kettlebells total) RACKKD
- KB4242PU220R** 2-20kg Urethane Dumbbells 2kg incs, (10 pairs, 20 total), 4-24kg SBX Kettlebell Set x 2 (12 Kettlebells total) RACKKD.
- KB4242RB225R** 2.5-25kg SBX Dumbbells 2.5 incs, (10 pairs, 20 total), 4-24kg SBX Kettlebell Set x 12 Kettlebells total) RACKKD.

RACK SPECIFICATIONS.

RACKKD Rigid Kettlebell and Dumbbell Rack
Holds up to 10 Dumbbell pairs and 12 Kettlebells.
Size: 1964mm x 700mm x 1147mm (as shown)

STRENGTH.

PLATES.

Whatever your lifting needs – technique, training or competition – our comprehensive collection of plates means there’s a solution for you. Enhancing the essential functionality of each plate without taking away from its primary purpose. Bright and engaging colours have been cleverly combined with high-quality materials to create a range that will inject energy and give your free weight area the ultimate USP.



COMPARISON CHART.

FEATURES.	EVERGREEN URETHANE GRIP PLATES.	RUBBER GRIP PLATES.	ELITE URETHANE BUMPER PLATES.	RUBBER BUMPER PLATES.
USE	Heavy use, strength training spaces	Light to moderate use strength areas	Heavy use facilities, Olympic lifting, cross training	Olympic lifting, cross training
MATERIAL	Urethane, Recycled material, Stainless steel core	SBX Rubber, Cast iron, stainless steel core	Urethane, machined steel core	Solid rubber
WEIGHTS/ THICKNESS	1.25kg – 26mm 2.5kg – 30mm 5kg – 37mm 10kg – 46mm 15kg – 49mm 20kg – 54mm 25kg – 56mm	1.25kg – 23mm 2.5kg – 24mm 5kg – 30mm 10kg – 38mm 15kg – 42mm 20kg – 44mm 25kg – 44mm	5kg – 25mm 10kg – 40mm 15kg – 46mm 20kg – 56mm 25kg – 61mm	5kg – 30mm 10kg – 35mm 15kg – 42mm 20kg – 46mm 25kg – 58mm
DUROMETER RATING (HARDNESS*)	80°	80°	89°	-
INTERNAL DIAMETER	51mm	51mm	50.5mm	50.8mm
WEIGHT TOLERANCE	1.25-10kg +/-10% 15-25kg +/-5%	+/- 10%	+/- 2%	+/- 2%
WARRANTY	5 years	3 years	3 years	1 year

*The higher the hardness rating the less bounce.

HOW TO CHOOSE.

EVERGREEN URETHANE GRIP PLATES.

Designed with cut-outs to allow you to separate plates and prevent them locking together. Made from hardwearing 20% Urethane and 80% recycled end of life materials, with side numbering for easy weight identification, these plates have stainless steel centres.



RUBBER GRIP PLATES.

There is a lot of choice when it comes to buying bumper plates for your facility. The Rubber Grip Plates are great all-rounders, with a simple no-fuss design. These plates are versatile and durable, built to last, lift after lift.



WHILST STOCKS LAST.

ELITE URETHANE BUMPER PLATES.

Outstanding durability, tight weight tolerances and low-bounce performance set these plates apart for the ultimate Olympic lifting experience. Inbuilt grip inserts and grip lips, enhanced vibrant colours and clear weight numbers make these plates appealing and accessible.



RUBBER BUMPER PLATES.

These rubber bumper plates are impact absorbing and scratch resistant. The design of these back-to-basics bumper plates might seem simple in aesthetics but they are an effective way of bulking out any barbell set up.



TURN TO PAGE 191 FOR WARRANTIES

EVERGREEN URETHANE GRIP PLATES.

HANDLES.
Anti locking grip to separate plates easily.

MATERIALS.
Made from 20% Urethane and 80% Recycled materials.

MORE THAN JUST A PLATE.
Contoured grip line for finger to forearm strength.

CORE.
Stainless steel centre to protect bar.



EPUGD012	1.25kg	Evergreen Urethane Grip Plate
EPUGD025	2.5kg	Evergreen Urethane Grip Plate
EPUGD050	5kg	Evergreen Urethane Grip Plate
EPUGD100	10kg	Evergreen Urethane Grip Plate
EPUGD150	15kg	Evergreen Urethane Grip Plate
EPUGD200	20kg	Evergreen Urethane Grip Plate
EPUGD250	25kg	Evergreen Urethane Grip Plate

URETHANE GRIP PLATE SETS.

EPUGD1252 1.25-25kg Eco Urethane Grip Plate Set (2 of each)
Speak to your sales representative about custom branding your grip plates.



EVERGREEN BARBELL™

RUBBER GRIP PLATES.

HANDLES.
Anti locking grip to separate plates easily.

NUMBERING.
Moulded numbering for weight identification.

CORE.
Stainless steel centre to protect bar.



MORE THAN JUST A PLATE.
Contoured grip line for finger to forearm strength.

WHILST STOCKS LAST.

RBGD01	1.25kg	Nucleus Rubber Grip Plate
RBGD02	2.5kg	Nucleus Rubber Grip Plate
RBGD05	5kg	Nucleus Rubber Grip Plate
RBGD10	10kg	Nucleus Rubber Grip Plate
RBGD15	15kg	Nucleus Rubber Grip Plate
RBGD20	20kg	Nucleus Rubber Grip Plate
RBGD25	25kg	Nucleus Rubber Grip Plate

RUBBER GRIP PLATE SETS.

RBGD1252 1.25-25kg Nucleus Rubber Grip Plate Set (2 of each)
RBGD1254 1.25-25kg Nucleus Rubber Grip Plate Set (4 of each)

GRIP PLATE SETS WITH WEIGHT TREE.

RUBBER GRIP PLATES RACK SET.

RBGD1254R 1.25-25kg Rubber Grip Plate (4 of each) WTREE2

RACK SPECIFICATIONS.

WTREE2 Weight Tree
Holds up to 28 plates. 4 plates per pin.
Size: Size 700mm x 700mm x 1333mm.
Weight 21.5kg. Max load 490lb. Weight 47lb.



HARD-WEARING.

Urethane over a steel core shrugs off impacts to stay looking new for longer.

CORE.

Durable machined steel centre to protect bar.

GRIPPABLE.

Grippable ridge and finger castellations to make them easy to pick up and handle, whether vertical or horizontal.

ELITE URETHANE BUMPER PLATES.

For the best Olympic lifting experience, try Elite plates. Durable and 'low bounce' thanks to the Urethane, and especially tight weight tolerances, these plates deliver on every lift.



- PUBP05** 5kg Elite Urethane Bumper Plate – Black (Technique Only)
- PUBP10** 10kg Elite Urethane Bumper Plate – Green
- PUBP15** 15kg Elite Urethane Bumper Plate – Yellow
- PUBP20** 20kg Elite Urethane Bumper Plate – Blue
- PUBP25** 25kg Elite Urethane Bumper Plate – Red

RACK SPECIFICATIONS.

OTR001 Toast Rack
Holds 2x complete sets of Elite Bumper Plates
Size: 1092mm x 300mm x 300mm. Weight 27kg.

Plates sold individually.



STRENGTH.

GRIPPABLE.

Grippable ridge and finger castellations to make them easy to pick up and handle, whether vertical or horizontal.

HIGH-STRENGTH.

High-strength rubber shrugs off impacts to stay looking new for longer.

CORE.

Strong stainless-steel pressed centre.

RUBBER BUMPER PLATES.

These high-strength plates shrug off impact with minimal bounce and are moulded with weight indicators. They may have a simple design, but are built to last, lift after lift.



WHILST STOCKS LAST.

- RBBP05** 5kg Rubber Bumper Plate
- RBBP10** 10kg Rubber Bumper Plate
- RBBP15** 15kg Rubber Bumper Plate
- RBBP20** 20kg Rubber Bumper Plate
- RBBP25** 25kg Rubber Bumper Plate

RACK SPECIFICATIONS.

OTR001 Toast Rack
Holds 2x complete sets of Rubber Bumper Plates
Size: 1092mm x 300mm x 300mm. Weight 27kg.

Plates sold individually.

EVERGREEN ECO REP SET.

Manufactured from 50% recycled materials in our dedicated eco-plant, the Evergreen Eco Rep set offers a no compromise experience that is good for the athlete and good for the planet.



DESIGN.
Clamp Collars with fast locking system.

ECO-FRIENDLY.
Made with over 50% recycled product.



MATERIALS.
Durable, urethane end caps to protect flooring.

USER-FRIENDLY.
Easy grip handles for comfort.



EVERGREEN BARBELL™

ECOREPS Urethane Eco Rep Set
ECOREP10R 10 Eco Rep Set with Rack
ECOREP5R 5 Eco Rep Set with Rack

RACK SPECIFICATIONS.
 Size: 669mm x 874mm x 1671mm. Weight 34kg.



RACKRS.

STRENGTH.

BARS.

From the very first coaching sessions through to Olympic lifts, Escape has a bar to cover all bases. Made from quality materials to exacting specifications, across this range there's a bar to enable every user to lift harder and heavier in total confidence.



COMPARISON CHART.

FEATURES.	CURL BAR.	JUNIOR BAR.	WOD BAR.	POWER BAR.
USE	Strength Training	Technique Training	Cross Training	General Strength Training
WEIGHT	9kg	12kg	20kg	20kg
LENGTH	1143mm	1520mm	2200mm	2200mm
SHAFT DIAMETER	25mm	28mm	28mm	28mm
SLEEVE LENGTH	152mm	253mm	410mm	410mm
KNURL	Single mark no centre knurl	Single mark no centre knurl	Single mark no centre knurl	Centre knurl
SHAFT FINISH	High Alloy Steel	High Alloy Steel	High Alloy Steel	High Alloy Steel
TENSILE STRENGTH	N/A	N/A	162k PSI	128k PSI
BUSHING/BEARING	2 bronze bush bearing (1 per sleeve)	2 x Bronze bush bearing (1 per sleeve)	8 needle bearing (4 per sleeve)	4 needle bearing (2 per sleeve)
HEAT TREATMENT	N/A	N/A	Twice	Twice
MAX LOAD	100kg	150kg	500kg	250kg
WARRANTY	1 year	1 year	1 year	1 year
PERFORMANCE				
WHIP	N/A	N/A	★★★★★	★★★★★
KNURL COURSENESS	N/A	N/A	★★★★★	★★★★★
ROTATION	N/A	N/A	★★★★★	★★★★★

★★★★★ = High
 ★★★★★ = Low

POWER BAR.

A great cross training all-rounder, and an ideal entry point for anyone progressing to Olympic lifting for the first time.



POWER01 20kg Power Bar

WOD BAR.

For Olympic lifts with no compromise. Maximum rotation and whip for faster transitions between sections of a snatch or clean and jerk.



WOD001 20kg WOD Bar

JUNIOR BAR.

For beginners or technique training, this lighter junior bar is the perfect introduction to the world of weightlifting.



JUNR01 12kg Junior Bar

CURL BAR.

A great strength training tool. Keeps your wrists at the perfect angle when performing reps in comfort and safety.



CURL01 9kg Olympic Curl Bar

STRENGTH.

LIFT PLATFORMS.

Elevate your workout space with our heavy-duty lifting platform, the Lift Zone. Designed to fit seamlessly with the Octagon range, it offers superb shock absorption to protect your flooring when dropping bumper plates. Compatible with single, double, or freestanding frames, this grippy and portable platform is easy to assemble.



DURABLE.
Robust, resilient and slip resistant

DESIGN.
43mm thick tiles, connected using heavy duty nylon dowel-lock system

VERSATILE.
Free laying (not bonded) tiles

WORK ZONE.
Contrasting colours highlighting the work zone

INTEGRATED LIFT PLATFORMS.

SINGLE LEG LIFT PLATFORM.

Integrates with the Octagon (as shown) and Quad Frame.

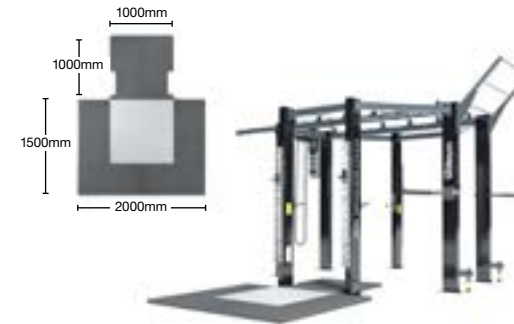

LIFTPLAT5 Integrated Lift Zone - Single Bolted Leg

DOUBLE LEG LIFT PLATFORM.

Integrates with the Half Box (as shown) and Half Squad.

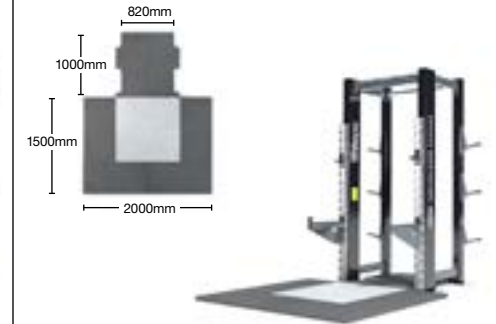

LIFTPLAT6 Integrated Lift Zone - Double Bolted Leg

FREESTANDING LEG LIFT PLATFORM.

Integrates with the Freestanding Octagon, Half Squad and Squat Hub (as shown).

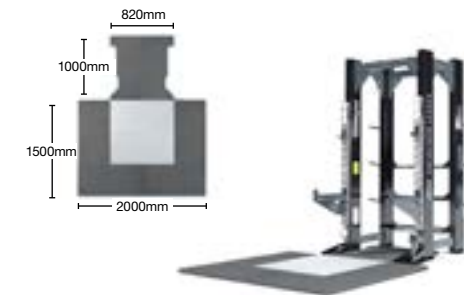

LIFTPLAT7 Integrated Lift Zone - Freestanding Leg

MONO LEG LIFT PLATFORM.

Integrates with the Mono (as shown).

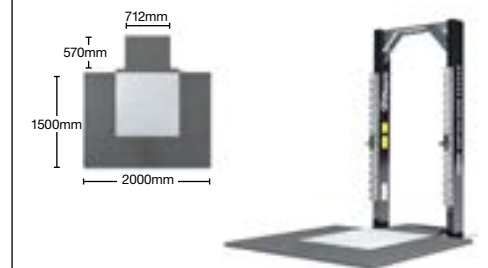

LIFTPLAT8 Integrated Lift Zone - MONO Bolted Leg

FREESTANDING PLATFORMS.

Designed to handle the demands of rigorous training, our stand alone platforms are ideal if you are wanting to create dedicated lifting areas around your gym.

LIFTPLAT3.

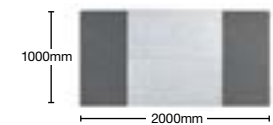

LIFTPLAT4.

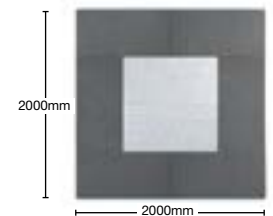

- LIFTPLAT3** Lift Zone Basic Small
- LIFTPLAT4** Lift Zone Basic Large

SPECIFICATIONS.

Basic Small: 2000mm x 1000mm x 43mm.
Basic Large: 2000mm x 2000mm x 43mm.

STRENGTH.

OLYMPIC BAR HOLDER AND COLLARS.

Intelligent space-saving storage solution for up to nine Olympic bars placed vertically, maximising floor space and utilising a tiny footprint and a range of collars which have been expertly developed and rigorously tested to ensure your plates remain secure at all times, no matter the intensity of the lifting.



- 01. BARH9** Olympic Bar Holder
Holds up to 9 bars.
Size: 500mm x 500mm x 254mm. Weight 18kg
- 02. WODC01** 52mm WOD Collar – Black – Pair
Internal Diameter 2"/52mm. Weight 7oz/0.2kg.
- 03. SA7113** 52mm Olympic Spring Collar – Each
Internal Diameter 2"/52mm. Weight 99 oz/2.8 kg.
- 04. KAMCOL2** 52mm Olympic Clamp Collar – Red – Pair
Internal Diameter 2"/52mm. Weight 6oz/0.17kg.



BASESTATION.

Lightweight, folding squat rack with an assemble and disassemble time of under a minute, this is the ultimate mobile squat rack. The 8-point stainless steel catch rack provides multiple height adjustments whilst the wide base negates the need for floor fixings.



BASESTN1 BASESTATION
SPECIFICATIONS.
Size: 1613mm H x 1133mm W x 1234mm. Weight: 40kg

FOLDS DOWN.
Folds down for easy transportation.

STRENGTH.

STRONGBOX.

This revolutionary, all-in-one workout bench will appeal to design conscious gyms who want to attract, and retain members. A next-level training bench, plyo platform and equipment storage unit, STRONGBOX not only demands attention, but speeds up transitions and enhances safety, storing equipment, including Nucleus Dumbbells, neatly to hand.

Using the same steel construction, STRONGBOX's ergonomically designed octagon-shaped back pads allow clearance for exercises while your back remains supported. With an adjustable back rest and a high-density urethane pad to accommodate weighted step ups, this is a dedicated, permanent station that keeps members in one place, for an entire workout.



PLEASE NOTE:
Accessories sold separately.

STRBOX2V2 STRONGBOX

STRBDB STRONGBOX with Dumbbells
Includes: 6x Rubber Dumbbells 2.5kg-15kg

STRBEP STRONGBOX with Equipment Pack
Includes: 6x Rubber Dumbbells 2.5kg-15kg
1 x 8kg and 12kg Rubber Kettlebell,
1 x 5kg VERTMINI, 1 x 8kg GRIPR,
1 x Resistance Tube 02 Green

SPECIFICATIONS.
Size 1306mm x 515mm x 520mm. Weight 90kg empty.



SIX LEVEL INCLINE.
Fully adjustable back pad.

INJECTION MOLDED PADS.
Injection molded pads are tough and hygienic.

BACK PADS:
Octagon-shaped back pads provide range of motion clearance.

DUMBBELL PROTECTORS.
Urethane encased dumbbells protectors.

HOOKS.
Hooks to attach bands for resistance-focused movements.

WHEELS.
Wheels to make the box easily portable, for storage or workout.

PRODUCT STORAGE.
Shelving for products such as GRIPRs, resistance tubes, medicine balls, or even keys and mobile phones safeguards equipment to free up the gym floor.



ADJUSTABLE BENCH.

A staple of strength training and more, the Adjustable Bench is one of the most versatile workout stations available. Seven levels of incline/decline on the backrest and three on the seat make for a variety of options and flexibility for users to target any area of the body.



ADJBEN2 Adjustable Bench

SPECIFICATIONS.

Size: 1325mm x 415mm x 585mm. Weight: 37kg.

STRENGTH.

DECK 2.0.

With 16 configurations across Step, Ramp and Bench modes, DECK 2.0 is perfect for step, circuits, BODYPUMP™ or Bootcamp workouts, enabling the creation of multiple full body workouts from one training bench. An ideal training deck in 1-on-1 or group environments, pair the DECK 2.0 with our space-saving STAKRBELL dumbbell options and you have a winning combination.



INTELLIGENT GRIP.

Texture varies across the surface to match up with the demands of hands or feet in particular areas.

EQUIPMENT STORAGE.

The perfect space for a full set of STAKRBELL and resistance bands, creating a fully equipped workout station

ANATOMIC HOT SPOTS.

Targets help guide users to where their hands and feet should be on every rep.

STAKRBELLS.

The STAKRBELLS tucks away seamlessly in the integrated storage space forming a self-contained training solution. See page 25.

EST-DECK DECK 2.0

TRAIN12 DECK 2.0 Product Training Workshop

SPECIFICATIONS.

Size 205mm (flat), 1100mm x 980mm (extended) x 330mm. Weight 13kg.

STEP PLATFORM SOLUTION.

Use a single STEP for classic step exercises, raise the height with RISERS for more challenge, or create an inclined platform for extra stepping options or bench work. Versatility is guaranteed and it's easy to switch between configurations mid-workout.

Both platform and riser are made from polypropylene that's strong yet allows a little 'give' to protect joints, whilst the anti-slip properties of the top mat and stabilising blocks mean even rapid movements can be performed safely.

STEP.



RISERS RAISING STEP.



RISERS RAISING STEP INTO INCLINE POSITION.



ANATOMIC HOT SPOTS.

Precise targets as a guide for correct foot and hand positions, and to hit in combinations for endless variety and challenge.



HEAT WELDED TOP MATS.

Instead of simply gluing the mats to the STEP and RISER they are attached via more robust heat welding for long-term performance.

LOCKING CONNECTORS.

Line up the red connectors and a firm push locks STEPs and RISERS securely together.

REGISTERED DESIGN.

- STEP01** x1 STEP
- STEP03** x3 STEPs Pack
- STEP04** x1 STEP and x2 RISERS
- STEP05** x1 STEP and x4 RISERS
- STEP07** STEP Club Pack (x3 STEPs and x6 RISERS)

SPECIFICATIONS.

STEP01: Size: 1063mm x 446mm x 107mm. Weight 6.23kg.

THE ESCAPE RISER.

The Escape RISER increases the height of the STEP platform or is a stepping platform in its own right. Wide enough to step on, but narrow enough to straddle – the RISER can be used to create dynamic workouts that get the user moving in all planes of motion.

The riser is inexpensive, and yet extremely versatile. Incorporate it into strength work to increase the distance to floor and therefore the depth and range of motion, enhancing the muscle recruitment.



- STEP02** x1 RISER
- STEP06** x6 RISER Pack

SPECIFICATIONS.

STEP02: Size: 434mm x 434mm x 105mm. Weight 1.85kg.

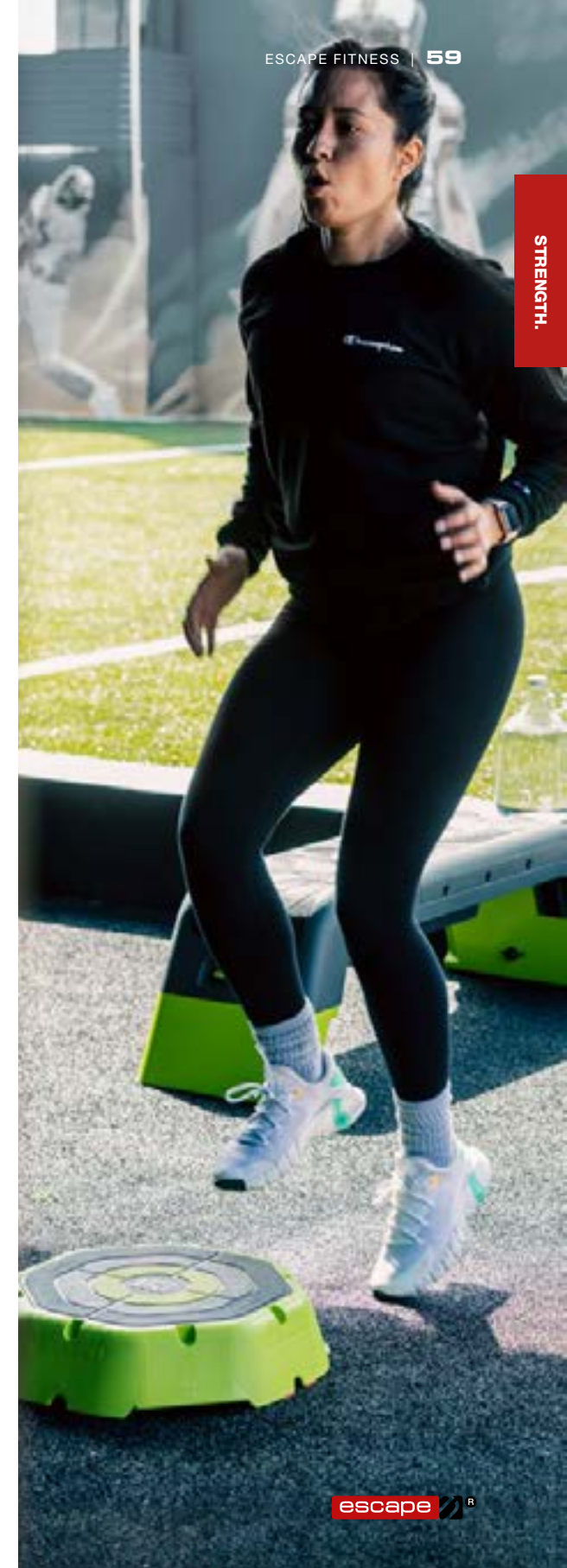

OCTAGON.

There is one piece of equipment that grabs user attention like no other – the challenging and versatile functional frame.

With endless configuration possibilities, Escape's Octagon range stands out from the rest. Suitable for members of all fitness levels, from beginner to athlete, our functional frames and storage-focused products deliver comprehensive solutions to optimise any training environment.

THE OCTAGON	
FRAME RANGE	62
T1 TOWER	64
HIT HUBS	66
HTS	74
OCTAGON	80
SQUAT FRAMES	82
BOXING FRAMES	88
ATTACHMENTS	92
FRAME DESIGN	96

THE OCTAGON FRAME RANGE.

Escape offers multiple configurations of frames, all which can be further customised with innovative storage solutions and optional attachments to create the ultimate training environment.

From compact, corner solutions that bring to life underutilised areas through to eye-catching centrepieces that demand attention, our range offers unrivalled flexibility.

Here are some options to get your started.



T1 TOWER.

A versatile, entry-level frame great for small areas. Available off the shelf or fully customisable.



WALL-BASED FRAMES.

Fully customisable, modular HIT HUBs with attachments and integrated storage solutions.



HTS.

A versatile frame with integrated storage and bridge design to maximise floor space.



CORNER.

A tucked-away, training and storage solution that optimises every inch of space.



OCTAGON.

The ultimate freestanding or bolt-down frame for a totally loaded, multi-station training experience.



SQUAT.

A must-have, versatile frame for any club looking to support a serious strength training program.



BOXING.

Fixed frame for incorporating Escape's unique BOA Rail technology for ultimate training flexibility.



CUSTOM.

Design your bespoke training environment with Escape's interconnecting modular frame and attachment system.



T1 TOWER.

Available as an off-the-shelf or a customisable frame, this compact, freestanding, 'entry-level' unit is designed to be the smallest of our range, and also the most affordable. It offers a multitude of exercise options and delivers a highly inclusive exercise experience, ideal for both the fitness beginner through to the seasoned athlete.



TYPE 01.

DIMENSIONS.



ATTACHMENTS.

- x1 Boxing Arm and Swivel.
- x1 Pull-Up Station.
- x1 Fixed Dip Station.
- x1 Claw Step.
- x2 Battle Rope Eye.
- x1 Torso Trainer.
- x1 Bar Holder.
- x1 Weight Horn.



OFFPOT04 T1 Tower, Type 01, Bolt Down with Boxing

PLEASE NOTE: Frame does not include Bar, Battle Rope, punchbag, plates or TRX.

TYPE 02.

DIMENSIONS.

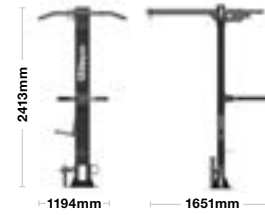

ATTACHMENTS.

- x1 Boxing Arm and Swivel.
- x1 Crux Rope Pulley.
- x1 Pull-Up Station.
- x1 Fixed Dip Station.
- x1 Claw Step.
- x2 Battle Rope Eye.
- x1 Torso Trainer.
- x1 Weight Horn.



OFFPOT05 T1 Tower, Type 02, Bolt Down with Boxing and Rope Pulley

PLEASE NOTE: Frame does not include Bar, Battle Rope, punchbag, plates or TRX.

TYPE 03.

DIMENSIONS.

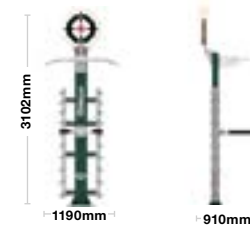

ATTACHMENTS.

- x1 Pull-Up Station.
- x1 Fixed Dip Station.
- x1 Claw Step.
- x1 Target.
- x2 Holster (holds 10 pairs of Dumbbells).



FCD05515-010 T1 Tower, Type 03, Bolt Down with Holster for Dumbbell Storage

PLEASE NOTE: Frame does not include Dumbbells.

HIT HUBS.

Bring any training area to life with our expertly designed HIT HUB. Forming part of our Octagon range, the HIT HUB benefits from a modular design that links bays to create the perfect frame that blends in with your space.

Available as single or double sided, bolt down or freestanding, with the option to add storage solutions, the HIT HUB offers a multitude of configurations.

Single sided is ideal for maximising limited or underused floor space whilst double sided provides zoned divisions, doubling the exercise stations, perfect for group exercise.

**HIT HUB -
THE MOST
VERSATILE
FRAME EVER
MADE.**



HIT HUB.

1 BAY SINGLE SIDED, BOLT DOWN FRAMES.

TYPE 01.

DIMENSIONS.

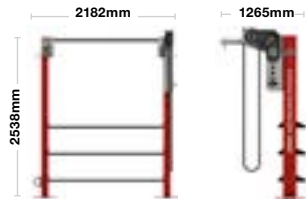

ATTACHMENTS.

- x1 Battle Rope Eye.
- x2 Claws for Storage.
- x1 Internal Hit Wing.
- x1 Boxing Arm and Swivel.
- x1 Crux Rope Pulley.
- x3 Flat Shelves with rubber mats.



PLEASE NOTE:
Frame does not include Battle Rope, Kettlebells, Balls, Bags Punchbag, Resistance Bands or WOD Rings.

FCD05515-02E HIT HUB 1 Bay, Type 01, Single Sided, Bolt Down with Boxing and Rope Pulley

TYPE 02.

DIMENSIONS.

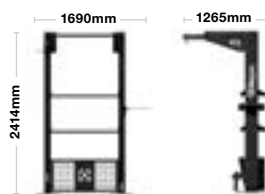

ATTACHMENTS.

- x1 Internal Hit Wing.
- x1 Battle Rope Eye.
- x1 Claw for Storage.
- x1 Boxing Arm and Swivel.
- x1 Torso Trainer.
- x1 Storage Cage.
- x1 Mat Rack.
- x2 Flat Shelves with rubber mats.



PLEASE NOTE:
Frame does not include Bar, Battle Rope, Kettlebells, Balls, Punchbag, Mats or TRX.

FCD05515-02D HIT HUB 1 Bay, Type 02, Single Sided, Bolt Down 1m with Boxing

HIT HUB.

2 BAY SINGLE SIDED, BOLT DOWN FRAMES.

TYPE 01.

DIMENSIONS.

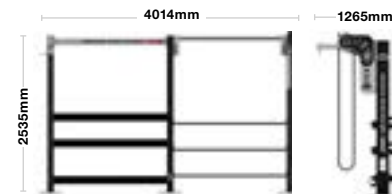

ATTACHMENTS.

- x1 Internal HIT Wing.
- x1 Battle Rope Eye.
- x1 Claw for Storage.
- x1 Boxing Arm and Swivel.
- x1 Crux Rope Pulley.
- x3 Dumbbell Shelves.
- x3 Flat Shelves with rubber mats.



PLEASE NOTE:
Frame does not include Battle Rope, Kettlebells, Balls, Bags, Dumbbells or WOD Rings.

FCD05515-02I HIT HUB 2 Bay, Type 01, Single Sided, Bolt Down with Boxing and Rope Pulley

TYPE 02.

DIMENSIONS.

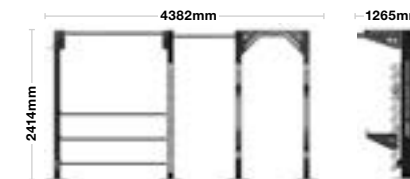

ATTACHMENTS.

- x1 Internal Hit Wing.
- x1 Battle Rope Eye.
- x1 Claw for Storage.
- x1 Catch Rack Set Pair.
- x1 Extended Catch Rack Pair.
- x1 Boxing Arm and Swivel.
- x1 Pull-Up Bar.
- x2 Adjuster Teeth.
- x1 The Holster (holds 5 pairs of Dumbbells).
- x1 Bar Holder
- x3 Flat Shelves with rubber mats.



PLEASE NOTE:
Frame does not include Punchbag, Bar, Plates Battle Rope, Kettlebells, Balls, Bags, Dumbbells or WOD Rings.

FCD05515-02H HIT HUB 2 Bay, Type 02, Single Sided, Bolt Down with Boxing, Holster and Lifting Station

HIT HUB. FREESTANDING BOXING FRAMES.



TYPE 01.

DIMENSIONS.

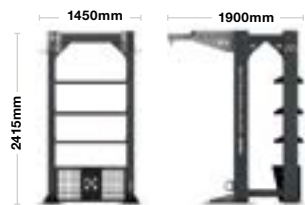

ATTACHMENTS.

- x1 Battle Rope Eye.
- x2 Claws for Storage.
- x1 Internal Hit Wing.
- x1 Fixed Dip Station.
- x1 Boxing Arm and Swivel.
- x3 Flat Shelves with rubber mats.
- x1 Storage Cage.



PLEASE NOTE:
Frame does not include Battle Rope, Kettlebells, Balls, Bags, Resistance Bands or TRX.

FCD05515-02W HIT HUB 1 Bay, Type 01, Single Sided, Freestanding 1m with Boxing

TYPE 02.

DIMENSIONS.

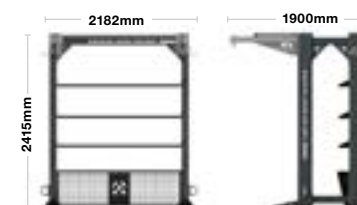

ATTACHMENTS.

- x1 Battle Rope Eye.
- x2 Claws for Storage.
- x1 Internal Hit Wing.
- x1 Fixed Dip Station.
- x2 Boxing Arm and Swivel.
- x3 Flat Shelves with rubber mats.
- x1 Storage Cage.



PLEASE NOTE:
Frame does not include Battle Rope, Kettlebells, Balls, Bags, Resistance Bands or TRX.

FCD05515-02X HIT HUB 1 Bay, Type 02, Single Sided, Freestanding with 2 x Boxing

HIT HUB. FREESTANDING FRAMES.



TYPE 01.

DIMENSIONS.

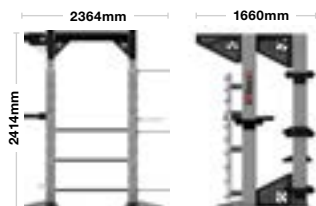

ATTACHMENTS.

- x1 Hit Wing 1M.
- x1 T1 Pull-Up Station.
- x1 Fixed Dip Station.
- x2 Claw Step.
- x3 Flat Shelves with rubber mats.
- x1 Mat Rack.
- x3 Gym Ball Holder.
- x2 The Holster (holds 10 pairs of Dumbbells).



FCD05515-02A HIT HUB 1 Bay, Type 01, Single Sided, Freestanding with Holsters and Gym Ball Storage

PLEASE NOTE: Frame does not include Dumbbells, Kettlebells, Balls, Bags, Mats or TRX.

TYPE 02.

DIMENSIONS.

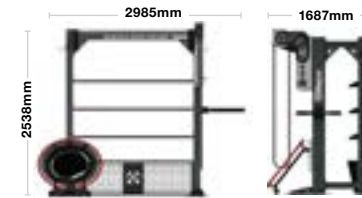

ATTACHMENTS.

- x1 Battle Rope Eye.
- x2 Claws for Storage.
- x1 Internal Hit Wing.
- x1 Fixed Dip Station.
- x1 Crux Rope Pulley.
- x1 Pro Bounder.
- x3 Flat Shelves with rubber mats.
- x1 Storage Cage.



FCD05515-02B HIT HUB 1 Bay, Type 02, Single Sided, Freestanding with Pro Bounder and Rope Pulley

PLEASE NOTE: Frame does not include Battle Rope, Kettlebells, Balls, Bags, Resistance Bands or TRX.

TYPE 03.

DIMENSIONS.

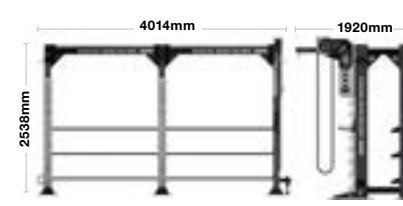

ATTACHMENTS.

- x1 Battle Rope Eye.
- x2 Claws for Storage.
- x2 Internal Hit Wings.
- x1 Boxing Arm.
- x1 Torso Trainer.
- x1 Weight Horn.
- x1 Bar Holder.
- x1 Crux Rope Pulley.
- x2 The Holster (holds 10 pairs of Dumbbells).
- x6 Flat Shelves with rubber mats.



FCD05515-02C HIT HUB 2 Bay, Type 03, Single Sided, Freestanding with Boxing, Holsters and Rope Pulley

PLEASE NOTE: Frame does not include Battle Rope, Bar, Plates, Kettlebells, Dumbbells, Balls, Bags, Resistance Bands or WOD Rings.

HTS.

The Hub Training System (HTS) can be both freestanding or bolt-down, providing a versatile, all-round functional training system with integrated storage solutions at either end and a bridge design to fully maximise workout space beneath the frame.

With optional monkey bars and additional functional training add-ons, the bridge converts the training space below the frame into an ideal personal training or group fitness workout zone.



OCTAGON.

TYPE 01.

ATTACHMENTS.

- x2 Raised Pull-Up Bar.
- x15 Monkey Bar.
- x2 Boxing Arm and Swivel.
- x2 Pull-Up Station.
- x2 Fixed Dip Station.
- x2 Claw Step.
- x2 Torso Trainer.
- x2 Bar Holder.
- x2 Battle Rope Eye.
- x2 Dock Target.
- x2 Ladder Wall Target.
- x2 CRUX Rope Pulley.
- x1 Pro Bounder.
- x2 Holsters (holds 10 pairs of Dumbbells).

DIMENSIONS.

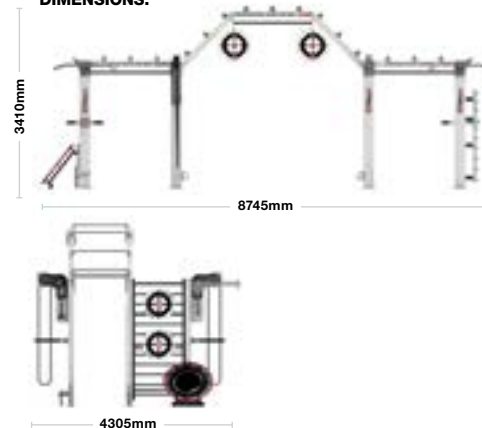

FCD05515-02V HTS, Type 01, Bolt Down with Bridge, Monkey Bars, Boxing, Holsters and Pro Bounder

PLEASE NOTE: Frame does not include Battle Rope, Dumbbells, Bars, Plates or WOD Rings.



TYPE 02.

ATTACHMENTS.

- x2 Raised Pull-Up Bar.
- x9 Monkey Bar.
- x2 Pull-Up Station.
- x2 Fixed Dip Station.
- x2 Claw Step.
- x2 Battle Rope Eye.
- x2 Dock Target.
- x2 CRUX Rope Pulley.
- x1 BOA Rail with 3 Boxing Bag Carriages.



DIMENSIONS.



PLEASE NOTE:

Frame does not include Battle Rope, Boxing Bags, TRX or WOD Rings.

FCD05515-02S HTS, Type 02, Bolt Down with Monkey Bars, Rope Pulley, BOA Rail and Dock Targets



TYPE 03.

ATTACHMENTS.

- x9 Monkey Bar.
- x1 Fixed Dip Station.
- x1 Pull-Up Station.
- x1 Claw Step.
- x1 Claw for Storage.
- x1 Torso Trainer.
- x1 Bar Holder.
- x1 Weight Horn.
- x4 Flat Shelves with rubber mats.
- x1 Ladder Wall Target.
- x1 Battle Rope Eye.
- x1 Pro Bouncer.
- x1 Dock Boxing Bracket.
- x2 Holster (holds 10 pairs of Dumbbells).



DIMENSIONS.

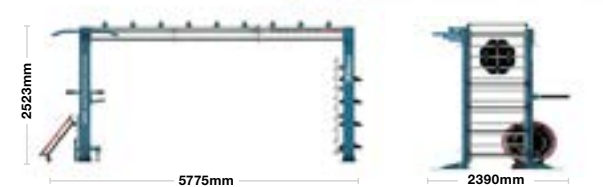

PLEASE NOTE:

Frame does not include Bar, Plates, Battle Rope, Kettlebells, Dumbbells, Balls, Bags, Resistance Bands or Boxing Bag.

FCD05515-02Q HTS, Type 03, Freestanding with Monkey Bars, Boxing, Holsters, Pro Bouncer and Ladder Wall Target

HTS 90

The HTS 90 takes the key features of the HTS concept and rearranges them into something that slots perfectly into corner spaces. It transforms these under-used corner spaces into revenue-generating assets.



TYPE 01.

DIMENSIONS.

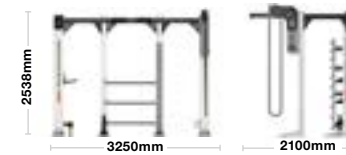

ATTACHMENTS.

- x1 Boxing Arm and Swivel.
- x1 Torso Trainer.
- x1 Set of Pull-Up Handles.
- x1 Battle Rope Eye.
- x1 Bar Holder.
- x1 Weight Horn.
- x1 Crux Rope Pulley.
- x1 The Holster (holds 5 pairs of Dumbbells).
- x3 Flat Shelves with rubber mats.

FCD05515-02K HTS 90 Corner Station, Freestanding with Boxing, Holsters and Rope Pulley

PLEASE NOTE:
Frame does not include Bar, Plates, Battle Rope, Kettlebells, Dumbbells, Balls or Bags.

TYPE 02.

DIMENSIONS.

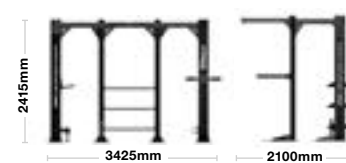

ATTACHMENTS.

- x1 Boxing Arm and Swivel.
- x1 Torso Trainer.
- x1 Set of Pull-Up Handles.
- x1 Fixed Dip Station.
- x1 Battle Rope Eye.
- x1 Bar Holder.
- x1 Weight Horn.
- x3 Flat Shelves with rubber mats.

FCD05515-02J HTS 90 Corner Station, Freestanding with Boxing

PLEASE NOTE:
Frame does not include Bar, Plates, Battle Rope, Kettlebells, Dumbbells, Balls, Bags or Boxing Bag.



OCTAGON™

The Octagon frame provides an eye-catching, standout, 360 training experience. Designed to be freestanding or bolt-down, this functional, multi-station frame offers an impressive centrepiece that demands attention and takes any training space up a gear.



REGISTERED DESIGN.

PLEASE NOTE:

Frame does not include Bars, Plates, Battle Rope, Kettlebells, Dumbbells, Balls, Bags or Boxing Bag.

DIMENSIONS.



ATTACHMENTS.

- x4 Monkey Bars.
- x1 Boxing Arm and Swivel.
- x1 Set of Pull-Up Handles.
- x1 Octagon SQR Pull Up Bar.
- x1 CRUX Rope Pulley.
- x2 Battle Rope Eye.
- x1 Fixed Dip Station.
- x4 Weight Horns.
- x1 Torso Trainer
- x2 Weight Stations.
- x2 Catch Rack Set Pair.
- x4 Adjuster Teeth.
- x1 Extended Catch Rack Pair.
- x2 Holster (holds 10 pairs of Dumbbells).
- x5 Flat Shelves with rubber mats.
- x1 Parallel Storage Shelf.

FCD05515-02P Octagon, Freestanding with Monkey Bars, Boxing, Rope Pulley, Lifting Station and Holsters

SQUAT FRAMES.

Those seeking high performance need training facilities to match. With our range of Octagon BOX training frames, elite users have the ideal partner for their squats, presses, pull-ups, big lifts and cardio exercises. These frames give professional sports gyms, universities, colleges and strength-based clubs the ability to provide safe and rewarding workout destinations for their more demanding users.



HALF BOX.

DIMENSIONS.

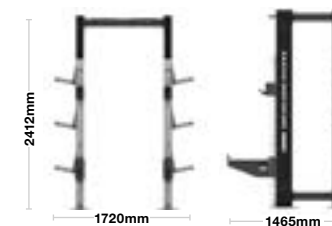

ATTACHMENTS.

- x1 Set of Pull-Up Handles.
- x6 Weight Horns.
- x1 Weight Station with Catch Racks and Extended Catch Racks.

PLEASE NOTE:

Frame does not include Bar or Plates.

OFPSQ10 Half Box Squat Frame, Bolt Down with Catch Racks and Extended Catch Racks



OCTAGON.

WOD BOX.

DIMENSIONS.



ATTACHMENTS.

- x1 Set of Pull-Up Handles.
- x1 Weight Station with Catch Racks and Extended Catch Racks.
- x1 Internal Weight Station with Catch Racks and Safety Straps.

PLEASE NOTE:

Frame does not include Bars or Plates.

OFPSQ13 WOD Box Squat Frame, Bolt Down with Internal and External Catch Racks and Extended Catch Racks





FREESTANDING SQUAT HUB.

DIMENSIONS.

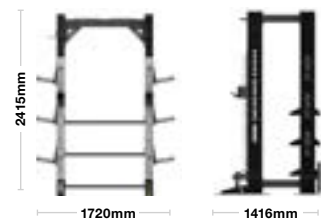

ATTACHMENTS.

- x1 Set of Pull-Up Handles.
- x1 Battle Rope Eye.
- x1 Torso Trainer.
- x1 Bar Holder.
- x6 Weight Horns.
- x1 Weight Station with Catch Racks.
- x1 Claw for Storage.
- x3 Flat Shelves with rubber mats.



OPFSQ14 Squat Hub Frame, Freestanding Lifting Station with Integrated Plate Storage

PLEASE NOTE:
Frame does not include Bar, Plates, Battle Rope, Kettlebells, Balls or Bags.



OCTAGON QUAD™.

DIMENSIONS.

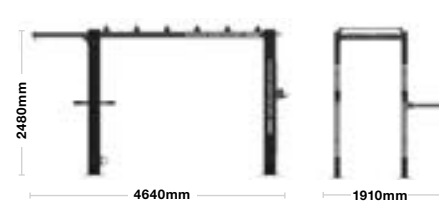

ATTACHMENTS.

- x1 Boxing Arm and Swivel.
- x1 Battle Rope Eyes.
- x1 Fixed Dip Station.
- x1 Set of Pull-Up Handles.
- x6 Monkey Bars.
- x2 Weight Horns.
- x1 Weight Station with Catch Racks.



OPFOT03 Quad Squat Frame, Bolt Down with Boxing, Monkey Bars and Lifting Station

PLEASE NOTE:
Frame does not include Bar, Plates, Battle Rope or Boxing Bag.

FREESTANDING MONO.

DIMENSIONS.

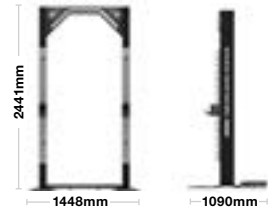

ATTACHMENTS.

- x1 Weight Station with Catch Racks.
- x1 Pull-Up Bar.

OFPSQ12 Mono Lifting Station, Freestanding with Catch Racks

PLEASE NOTE: Frame does not include Bar or Plates.

HALF SQUAD.



PLEASE NOTE: Frame does not include Bars, Plates, Dumbbells, Balls or Bags.

ATTACHMENTS.

- x2 Sets of Pull-Up Handles.
- x2 Dumbbell Shelves.
- x1 Flat Shelf.
- x1 Storage Rail.
- x2 Catch Rack Pairs.
- x2 Weight Stations.
- x2 Extended Catch Rack Pairs.
- x6 Weight Horns.

DIMENSIONS.



OFPSQ11 Half Squad, Bolt Down, 2 Lifting Stations with Catch Racks and Extended Catch Racks

OFPSQ09 Half Squad, Freestanding, 2 Lifting Stations with Catch Racks and Extended Catch Racks

OCTAGON.



BOXING.

Kicking, punching, jabbing and striking are all perfect for developing speed, strength, power and dexterity. Create a perfect combat training environment with our fixed bag frames or our HTS BOA Rail technology.

PACKING A PUNCH.



BOA RAIL.

The BOA Rail is a modular, secure anchor point for punch bags, which also enables trainers to quickly transition seamlessly from bag work into other complimentary training methods thanks to the user-friendly lock/unlock mechanisms.

WORKING POSITION.

Depending on the size of frame chosen, the BOA Rail provides capacity for two, three or four punchbags to be used at the same time.

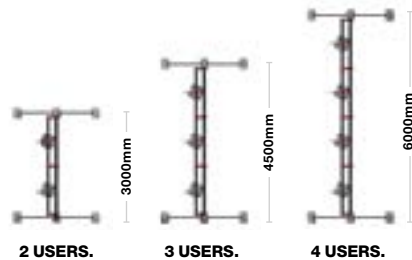

DOCKED POSITION.

When the boxing session is over, simply release the locking mechanism and slide each bag over for neat storage.

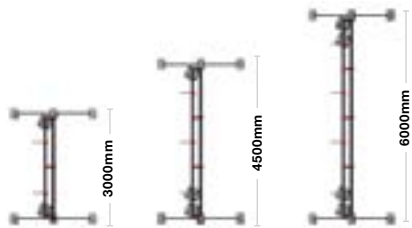

FCD05515-02T BOA Rail, Bolt Down holding 20 Boxing Bags



BOXING FRAME.

Whether for advanced combat classes or for beginner striking sessions, this modular frame works as a grid system and can be configured to hold a customised number of bags in fixed positions to meet the number of users, with the option to scale up or down in numbers easily. An efficient, space-saving solution and an adaptable option for all abilities.



DIMENSIONS.

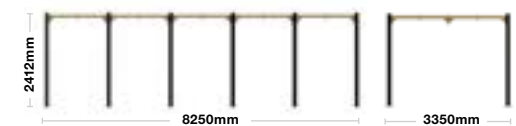

FCD05515-02U Boxing Frame, Bolt Down holding 12 Boxing Bags

OPTIONAL FRAME ATTACHMENTS, MAXIMUM FUNCTIONALITY.

CRUX ROPE PULLEY.

Constructed from a heavy-duty steel case and polypropylene rope, the CRUX was made to withstand the most challenging training sessions. This optional piece of kit is intuitive, beautifully designed, requires zero setup, and the adjustable resistance makes it suitable for all users.

Get to grips with the CRUX to elevate heart rate, build functional strength, and improve cardiovascular endurance.

DESIGN.

The CRUX Rope Pulley is designed to fit seamlessly with the Octagon frame range.

VARIABLE RESISTANCE.

No setup required. Simply select resistance level to get started.

POLYPROPYLENE SYNTHETIC ROPE.

Durable enough to withstand heavy commercial use without breaking down.

OCA093 CRUX Rope Pulley

PLEASE NOTE: additional mount plates may be required, please speak to sales representative for more information.

SPECIFICATIONS.
606mm x 175mm x 954mm.



BASE BENCH.

This lightweight pad supports the upper body whilst engaging muscles of the lower body to provide stability across a wide range of pushing and pulling exercises. This delivers a whole-body workout with every rep.

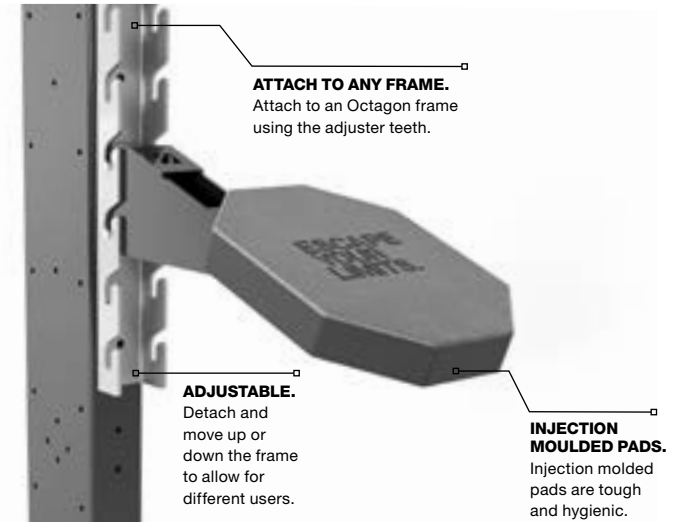

EXERCISES.

The BASE BENCH is suitable for a range of exercises.



SEATED PRESS.



CHEST PRESS.



ROW.



SPLIT SQUAT.

OCA110 BASE BENCH

SPECIFICATIONS.

317.5mm x 708.7mm x 228.6mm.

OCTAGON.

DESIGNED TO ORDER.

DESIGNED TO ORDER. INNOVATE, PREMIUM, STYLISH FRAMES.

In addition to our off-the-shelf frames, Octagon frames can be made bespoke, creating almost limitless opportunities for a frame unique to your brand or environment.

In 3 simple steps, our expertly trained designers will turn your dream frame into a functional reality.

Manufactured in the UK, handmade with skill and using only the most premium steel, we'll build you a frame that makes an impact and withstands the toughest of training settings.

3 SIMPLE STEPS TO MAKE YOUR DREAM FRAME A REALITY.

01.
DESIGNING
FOR IMPACT.

02.
ADDING YOUR
ATTACHMENTS.

03.
CHOOSE YOUR
COLOUR.

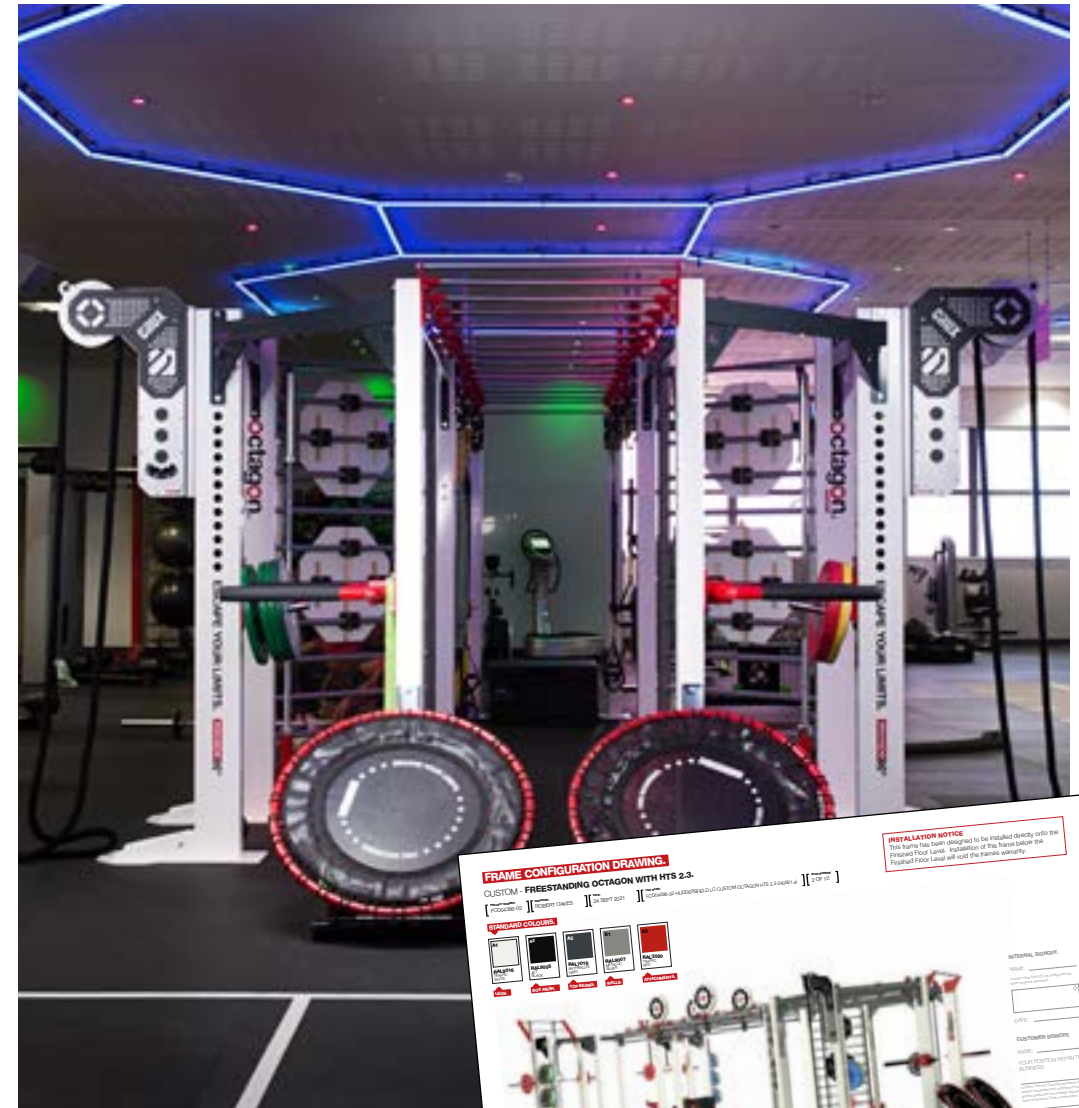

OCTAGON.

DESIGNED TO ORDER.

01.

DESIGNING FOR IMPACT.

All of our design experts have at least two years' experience building the most impressive functional training frames built to fit your individual needs.

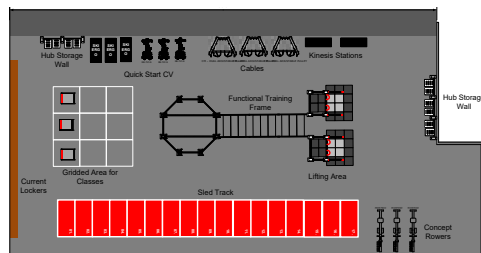

They will first help you plan your frame for maximum efficiency and effect, considering your floor space, desired training modalities and the environment.



Alongside this, our team will ensure we build a frame that is safe and future proofed.

OVER 25 YEARS INDUSTRY EXPERIENCE.

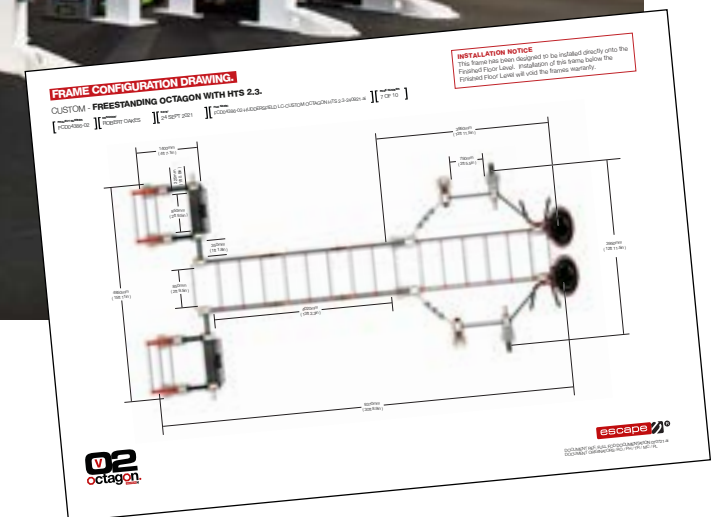
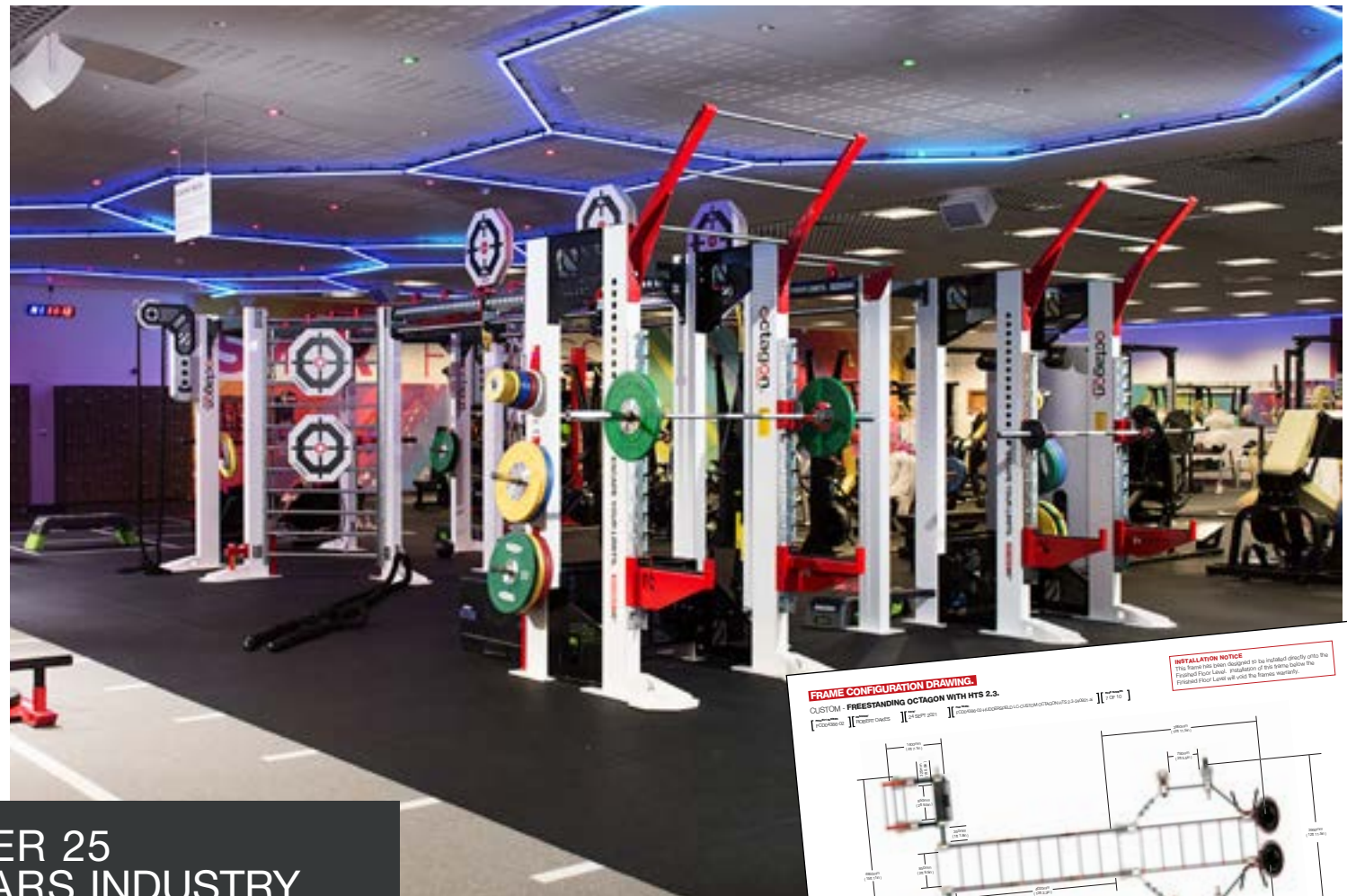

DESIGNED TO ORDER.

02. CHOOSING YOUR ATTACHMENTS.

Escape offers a wide selection of optional attachments to maximise and individualise the functionality and versatility of your bespoke Octagon frame.

A small selection of accessories are shown opposite. These include the new CRUX ROPE - the ultimate infinity rope training, and the STACK, the frame-mounted cable column with adjustable resistance.

If your training space has a low ceiling, there is the option to select a shorter frame leg.



Through our app, you can try an array of options - adding various attachments until you design the ultimate frame for your requirements. If you need a little extra help, our team is always on hand to help.

Please contact us or your sales representative for the full range of accessories available.

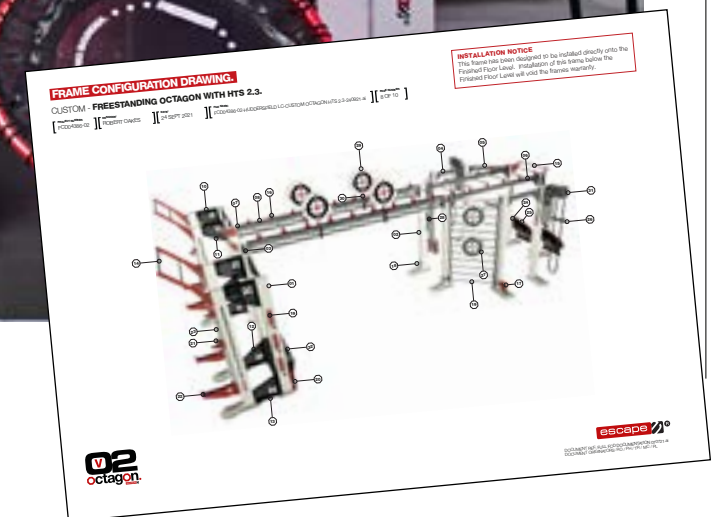

OCTAGON.

DESIGNED TO ORDER.

03. CHOOSING YOUR COLOUR.

Create a frame that stands out or blends into the environment, its your choice with our colour options.

Escape now offers an expanded range of colour options, giving you the opportunity to create functional frames that match your unique club branding and environment.

Bring your frame to life with our range of standard, premium or bespoke colours.

STANDARD COLOURS.

JET BLACK
RAL9005



ANTHRACITE GREY
RAL7016



TRAFFIC WHITE
RAL9016

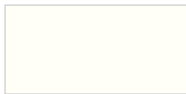

PREMIUM COLOURS.

METALLIC SILVER
RAL9007



TRAFFIC RED
RAL3020



TRAFFIC BLUE
RAL5017



YELLOW GREEN
RAL6018



RAPESEED YELLOW
RAL1021



TRAFFIC ORANGE
RAL2009



BESPOKE COLOURS.

If you would like to customise your frame to your brand, you can pick your own paint colour. Here's some inspiration.

GREEN BROWN
RAL8000



BLUE LILAC
RAL4005



TURQUOISE BLUE
RAL5018

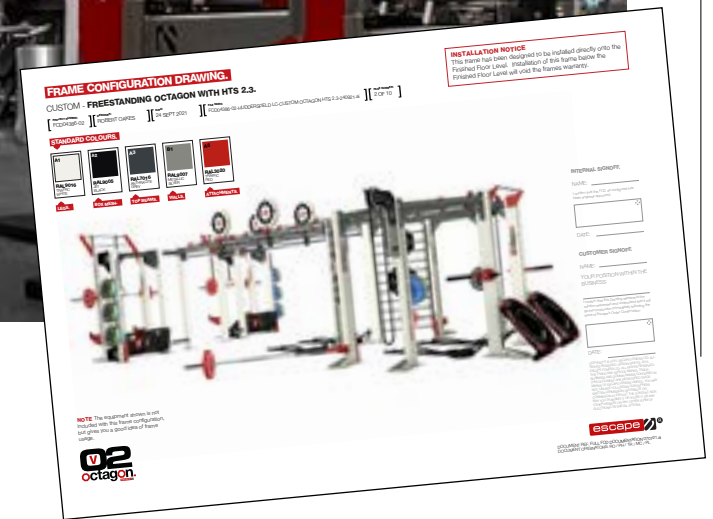
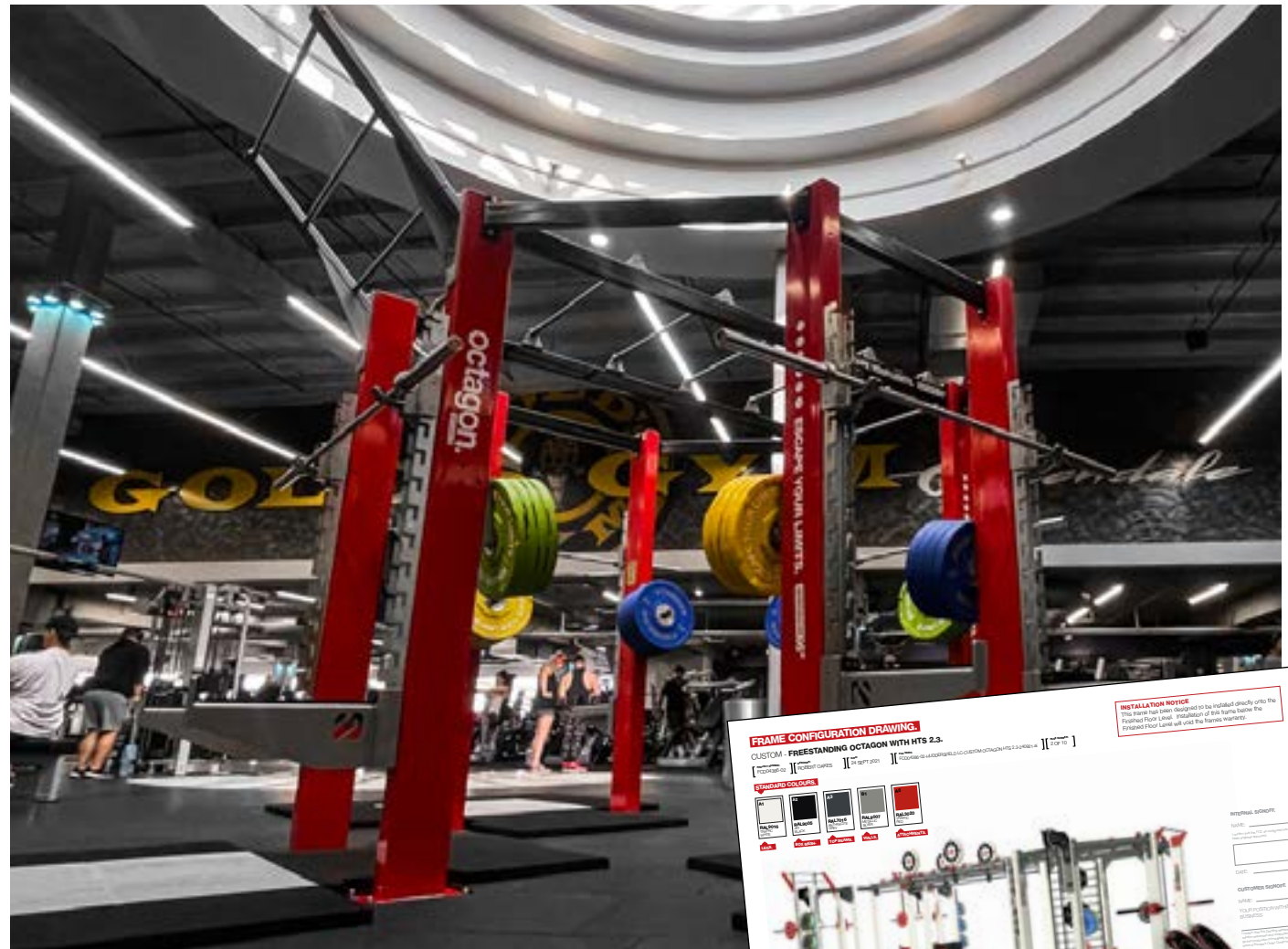

OCTAGON.

FUNCTIONAL.

Working in multiple planes of motion strengthens and conditions the whole body, from knees and ankles to shoulders and hips. The Escape range of functional training equipment provides the ideal starting point for this style of training, but also offers a more of a challenging workout for those really who need it.



BARROW	106
TIYR	108
QUAD SLED	110
SPEED TRAINING	111
GLUTE BOX	112
PLYO BOXES	114
TRAINING BAGS	118
MEDICINE BALLS	122
GRIPR	132
HANDWEIGHTS	133
PRO BOUNDER	134
CMT	134
WOD RINGS	135
BATTLE ROPES	135
AMMO BOX	136
POWER BANDS	136
JUMP ROPES	137
TRX	137
RACK5 PRODUCT PACKS	138

FUNCTIONAL.

THE NEXT BIG THING IN FITNESS.



SCAN FOR MORE INFORMATION.

BARROW.

Designed in partnership with Pete Holman, world renowned Strength Coach and Inventor of the TRX RipTrainer & Nautilus Glute Drive, The Escape Barrow is the only easy-load, back-safe and 'sexy as hell' machine that combines two essential exercise modalities; the loaded carry and the sled push.



HANDLES.
Multiple grip handles allow users to position their hands for exercises such as farmer's carries and sled pushes.

LOAD CAPACITY.
Impressive load capacity of 200kg.

MATERIALS.
Carbon steel frame and two plate loading points.

DURABILITY.
Galvanised for outdoor use and durability.

BARROW1 Barrow

SPECIFICATIONS.

Size: 1276mm x 859mm x 907mm. Weight: 62kg.

FUNCTIONAL.

PRESS, JUMP, FLIP, LIFT AND PULL.



SCAN FOR MORE INFORMATION.

THE TIYR.®

Made in the UK, the TIYR is soft yet very strong, simple but innovative. It's also super tough, just like the real thing.

HANDLES.

The ultra tough CORDURA® handles can be used for lifting and carrying, and as attachment points for Battle Ropes.



MATERIALS.

PVC cover with Clearguard lacquer finish and screen printed graphics over a reconstituted foam core.

PATENTED.

TIYR01	40kg	TIYR - Green with Handles
TIYR02	60kg	TIYR - Blue with Handles
TIYR03	80kg	TIYR - Red with Handles
TIYR04	100kg	TIYR - Black with Handles
TRAIN05		TIYR - Product Training Workshop

40kg

OUTSIDE DIAMETER:
870mm

INSIDE DIAMETER:
400mm

HEIGHT:
265mm



60kg

OUTSIDE DIAMETER:
1030mm

INSIDE DIAMETER:
500mm

HEIGHT:
314mm



80kg

OUTSIDE DIAMETER:
1200mm

INSIDE DIAMETER:
600mm

HEIGHT:
370mm



100kg

OUTSIDE DIAMETER:
1200mm

INSIDE DIAMETER:
600mm

HEIGHT:
370mm



FUNCTIONAL.

QUAD SLED.™

A simple, brutal workout tool that builds core and leg power. Stylish and compact, our sled features two moveable drive posts which can be positioned at either end of the sled and the low drive bar increases the challenge.

LOAD UP TO 150KG.
heavy loading options on the sled is great for even the strongest athlete.

ATTACH A BATTLE ROPE.
Front and back for a loaded heavy pull.

RUNNERS.
Nylon runners for use on specialist Speed Tracks or sport carpet type flooring.

QSLED Quad Sled

SPECIFICATIONS.

Size 970mm x 730mm x 1000mm. Weight 40kg.

Plates not included.

SPEED TRAINING.

Empower training potential realisation. Incorporate our range of hard wearing, colourful, SAQ products into speed and agility sessions. Great for group work catering to all abilities.



FUNCTIONAL.

- EST-SL** Speed Ladder
Size 3140mm x 510mm. (whilst stocks last)
- EST-AGS** Agility Grid System – Set of 6
Size 500mm x 580mm. (whilst stocks last)
- EST-LEH** Lateral Endurance Hurdle – Each
Size 310mm x 600mm x 200mm.
- EST-AH** Adjustable Hurdle – Each
Size 150-300mm. (whilst stocks last)
- EST-HC6** Speed Cones – Set of 6. (whilst stocks last)



THE ESCAPE GLUTE BOX.

With glute training on the rise. The Escape GLUTE BOX offers a portable and affordable solution to clubs. A revolutionary patented new training hybrid box that can be placed anywhere in a facility and partnered up with a favourite functional training tool and our MARS Functional Screen to assist with workout and exercise tuition.

Specifically designed to carry out more than 30 glutes exercises, in a more effective, comfortable and safe way.

TARGET ZONES.

Anti-slip design with targets on the top to aid users.

DESIGN.

Patented angled design makes training more effective, convenient and safe.



EXERCISE LIBRARY.

Unique versatility with more than 30 exercises for glutes and legs.

MATERIALS.

Durable vinyl cover tightly fitted over a firm foam filling.



700mm



350mm

400mm

550mm



SCAN FOR MORE INFORMATION.

GLBOX Glute Box

SPECIFICATIONS.

Size: 400mm x 75mm x 550mm. Weight 12kg.

FUNCTIONAL.

PLYOSOFT BOX.

Take your training experience to a new level with plyometrics. Open up opportunities for stable box jump patterns in frontal, lateral and transverse planes. Adding to the challenge are target markings as part of the top surface design, giving users precise areas to aim for.

PERFORMANCE.
Both top and bottom surfaces are made of anti-slip material for performance and stability.

FILLING.
Made in the UK from light weight foam.

DURABILITY.
For more durability, a tough outer material is tightly fitted over a firm foam filling.

SECURE.
Patented velcro tabs so you can safely stack the boxes.

150mm
300mm
450mm
600mm
914mm

TARGET HOT SPOTS.
Users can land their hands or feet on targets on the top surface for an extra challenge.



PATENTED.

CPLYOB05	Plyosoft Box 150mm/6" – Grey
CPLYOB1	Plyosoft Box 300mm/12" – Green
CPLYOB2	Plyosoft Box 450mm/18" – Blue
CPLYOB3	Plyosoft Box 600mm/24" – Red
CPLYS3	Plyosoft Box Set of 3 (Green, Blue, Red)
TRAIN07	Plyometric Product Training Workshop

MULTIPLYO®

We've taken the great idea of a 3-in-1 plyo box and given it the Escape treatment. Made to the same dimensions as the boxes used for cross training, this great space-saving box is the perfect tool to introduce beginners to plyometrics.

LANDING ZONES.
Anti-slip landing zones are on all six sides, and it's designed so that it won't move when in use.

FILLING.
Made in the UK from light weight foam.

COVER.
An easy-to-clean GTEX cover is securely heat welded over a foam core to avoid creasing.

FILLING.
Made in the UK from light weight foam.

510mm
610mm
760mm
762mm
508mm
610mm

PATENTED.

MULTIP2	MultiPLYO
TRAIN07	Plyometric Product Training Workshop
SPECIFICATIONS.	Size 510mm x 760mm x 610mm. Weight approx. 25kg.

FUNCTIONAL.

PLYOSOFT BOX® BLACK.

These soft plyometric boxes can be used individually or stacked for variable height options depending on ability and progress. The Patented velcro tabs hold them in place for safety and confidence when stacking, and they're light weight, so they're easy to move while in use or for storage.

SECURE.
Patented velcro tabs so you can safely stack the boxes.

COVERING.
Durable PVC covering.

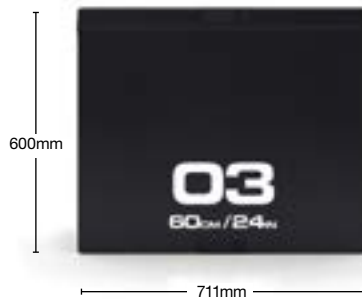

FILLING.
Made in the UK from High-density foam filling.

DESIGN.
Classic design and usability allows users to get back to the fundamentals and concentrate on what matters – performance.

PATENTED.

- BLPLYS1** Set of 3 Black Plyoboxes
- TRAIN07** Plyometric Product Training Workshop

SPECIFICATIONS.
Sizes: 01: 300mm. 02: 450mm. 03: 600mm.



FUNCTIONAL.



SCAN FOR MORE INFORMATION.



SCAN FOR MORE INFORMATION.

FITNESS BULGARIAN BAG.®

Bright colours, a range of weight options and a huge selection of different applications – the Fitness Bulgarian Bag should feature in every serious functional training zone.

WEIGHT RANGE.

High quality, hand-made in Bulgaria, the Fitness Bulgarian Bag comes in bright colours and weight options suitable for every functional training zone.



GRIP.

The handles, grips and straps mean the bag can be used for a range of different exercises.

COATING.

The Fitness Bulgarian Bag has a synthetic leather coating, making it easy to wipe down and keep clean.

- FVBBAG5V3** 5kg Fitness Bulgarian Bag – Green
- FVBBAG8V3** 8kg Fitness Bulgarian Bag – Blue
- FVBBAG12V3** 12kg Fitness Bulgarian Bag – Red
- FVBBAG17V3** 17kg Fitness Bulgarian Bag – Grey
- FVBBAG22V3** 22kg Fitness Bulgarian Bag – Black

TRAIN02 Bulgarian Bag - Product Training Workshop

RACK SPECIFICATIONS.

- RACKM5** 5 Shelf Rigid Multi Rack – Holds 5 bags
Size: 700mm x 700mm x 2089mm.
Max load per shelf 25kg. Weight 31kg
- RACKM10** 10 Shelf Rigid Multi Rack – Holds 10 bags
700mm x 700mm x 2089mm.
Max load per shelf 25kg. Weight 40.5kg.
- RACK5** RACK5 – Holds 10 bags
Size: 600mm x 699mm x 1896mm. Weight 75kg.
- RACKU2** 2 Shelf Universal Rack - Holds 18 bags
Size: 1964mm* x 700mm x 755mm
Max load: 300kg. Weight 53kg
- RACKU3** 3 Shelf Universal Rack - Holds 12 bags
Size: 1964mm* x 700mm x 1146mm
Max load: 300kg. Weight 75.5kg

Bulgarian Bags sold separately.



FUNCTIONAL.



COREBAG®

This fitness space staple makes functional training even more accessible for beginners or veterans alike. Deadlift, pull, press, swing and perform many other movements in comfort through great ergonomics and practical weight progression.

REGISTERED DESIGN.

- ECB050V3** 5kg Corebag – Green
- ECB100V3** 10kg Corebag – Blue
- ECB150V3** 15kg Corebag – Red
- ECB200V3** 20kg Corebag – Grey
- ECB250V3** 25kg Corebag – Black

TRAIN08 Corebag Product Training Workshop

RACK SPECIFICATIONS.

- RACKM5** 5 Shelf Rigid Multi Rack – Holds 5 bags
Size: 700mm x 700mm x 2089mm.
Max load per shelf 25kg. Weight 31kg
- RACKM10** 10 Shelf Rigid Multi Rack – Holds 10 bags
700mm x 700mm x 2089mm.
Max load per shelf 25kg. Weight 40.5kg.
- RACK5** RACK5 – Holds 10 bags
Size: 600mm x 699mm x 1896mm. Weight 75kg.
- RACKU2** 2 Shelf Universal Rack - Holds 18 bags
Size: 1964mm* x 700mm x 755mm
Max load: 300kg. Weight 53kg
- RACKU3** 3 Shelf Universal Rack - Holds 12 bags
Size: 1964mm* x 700mm x 1146mm
Max load: 300kg. Weight 75.5kg

Corebags sold separately.



MULTI RACK.

Minimal footprint but maximum impact, our Multi Rack stores functional training bags vertically to retain as much workout space as possible, whilst ensuring a safe training space. Available in two options, a single sided 5 shelf (as shown) or double sided 10 shelf rack.



SCAN FOR MORE INFORMATION.

TURN TO PAGE 191 FOR WARRANTIES

FUNCTIONAL.

MEDICINE BALLS.

There are different sizes, weights and textures across the range – and specialist features such as the VERTMINI's compact size and the Multi Grip Medball's integrated handles.



COMPARISON CHART.

FEATURES.	ENDURA BALL.	VERTBALL.	VERTMINI.	TOTAL GRIP.	MULTI GRIP.	SLAMBALL SBX.
USE	Personal training, general use	Cross training, PT zones	Team games, mobility and functional spaces	General PT and functional training where grip is key	Vigorous workouts, building core strength, rotational power	Functional zones, cross training, sports performance
WEIGHTS	1.5kg 2.5kg 3.5kg 4.5kg 5.5kg 6.5kg 7kg 8kg 9kg 11kg 13.5kg	3kg - Green 4kg - Blue 5kg - Red 6kg - Grey 7kg - Black 8kg - Green 9kg - Blue 10kg - Red	1kg - Green 2kg - Blue 3kg - Red 4kg - Grey 5kg - Black 6kg - Green 7kg - Blue 8kg - Red 9kg - Grey 10kg - Black	1kg 2kg 3kg 4kg 5kg	6kg 7kg 8kg 9kg 10kg	5kg - Green 10kg - Blue 15kg - Red 20kg - Black
DIAMETER	14"	35cm	1-5kg: 21cm 6-10kg: 25.4cm	24cm	23cm	23cm
FEATURE	Abrasion resistant extra grip textured surface	Oversized design to correct postural alignment	Sure-grip, soft surface ideal for throwing and rolling	Extra grip textured surface	Integrated handles for more movement options	Hardcore and durable for extreme training
WARRANTY	1 year	1 year	1 year	1 year	1 year	1 year

HOW TO CHOOSE.



ENDURA BALL.

Tough, durable and versatile. This is the ultimate soft, multi-purpose, medball. Slam it, lift it, chuck it. This ball will withstand high levels of training punishment.



VERTBALL™.

Designed to be caught and thrown at speed. Perfect for high velocity training. Throw it at a wall. Throw it to a partner. Throw it at the floor. Just throw it.



VERTMINI™.

An evolution of the classic VERTBALL. Small and soft, perfect for partner-games training and dynamic movements. Bright, attractive design.



TOTAL GRIP MEDBALL.

A fundamental of functional fitness, this classic rubber medball has a textured surface for a firm grip.



MULTI GRIP MEDBALL.

A practical twist on the classic medball. Integrated 'handles' add a new dynamic that supports even more movement options.



SLAMBALL SBX™.

Hardcore, rubber medball, designed for extreme training. This is the most durable, classic design medball in the Escape range.

FUNCTIONAL.



ENDURA BALL.

These are the toughest medicine balls in the Escape range, and double up as a great 2 in 1 slamball or medicine ball option. Designed for a variety of workouts that will push anyone to reach a new level of fitness.

MATERIAL.

A combination of synthetic polyester wool, rubber crush and cork make for robustness you can trust.



DURABILITY.

The hardwearing material of the ENDURA Ball makes it the ideal tool for heavy duty usage.

NUMBERING.

Oversized numbering stitched in makes for quick and easy weight identification.

FUNCTIONAL.

- ENDUR015** Endura Ball 1.5kg/4lbs
- ENDUR025** Endura Ball 2.5kg/6lbs
- ENDUR035** Endura Ball 3.5kg/8lbs
- ENDUR045** Endura Ball 4.5kg/10lbs
- ENDUR055** Endura Ball 5.5kg/12lbs
- ENDUR065** Endura Ball 6.5kg/14lbs
- ENDUR070** Endura Ball 7kg/16lbs
- ENDUR080** Endura Ball 8kg/18lbs
- ENDUR090** Endura Ball 9kg/20lbs
- ENDUR110** Endura Ball 11kg/25lbs
- ENDUR135** Endura Ball 13.5kg/30lbs

TRAIN04 Medicine Balls Product Training Workshop

RACK SPECIFICATIONS.

- RACKM5** 5 Shelf Rigid Multi Rack – Holds 5 balls
Size: 700mm x 700mm x 2089mm.
Max load per shelf 25kg. Weight 31kg
- RACKM10** 10 Shelf Rigid Multi Rack – Holds 10 balls
700mm x 700mm x 2089mm.
Max load per shelf 25kg. Weight 40.5kg.
- RACK5** RACK5 – Holds 20 balls
Size: 600mm x 699mm x 1896mm.
Weight 75kg (as shown)
- RACKU2** 2 Shelf Universal Rack - Holds 18 balls
Size: 1964mm* x 700mm x 755mm
Max load: 300kg. Weight 53kg
- RACKU3** 3 Shelf Universal Rack - Holds 12 balls
Size: 1964mm* x 700mm x 1146mm
Max load: 300kg. Weight 75.5kg

ENDURA Balls sold separately.



VERTBALL.™

The VERTBALL has been specifically designed for throwing – to a partner or against a wall. Because it's oversized it works muscles from the feet right up to the hands, and develops coordination, balance, acceleration and deceleration.



COLOURS.
Vibrant colours for instant appeal.

STITCHING.
Soft outer skin is constructed from 26 individually stitched leather panels to ensure the ball maintains its shape and flies straight through the air.

MATERIALS.
Outer material is synthetic leather with rubber granule filling to ensure ball does not break down over time.

LARGER SIZE.
The oversized design (diameter of 356mm) encourages correct posture, keeping the core engaged.

VERT03	3kg	VERTBALL – Green
VERT04	4kg	VERTBALL – Blue
VERT05	5kg	VERTBALL – Red
VERT06	6kg	VERTBALL – Grey
VERT07	7kg	VERTBALL – Black
VERT08	8kg	VERTBALL – Green
VERT09	9kg	VERTBALL – Blue
VERT10	10kg	VERTBALL – Red
TRAIN04	Medicine Balls Product Training Workshop	
RACK SPECIFICATIONS.		
RACKM5	5 Shelf Rigid Multi Rack – Holds 5 balls Size: 700mm x 700mm x 2089mm. Max load per shelf 25kg. Weight 31kg (as shown)	
RACKM10	10 Shelf Rigid Multi Rack – Holds 10 balls 700mm x 700mm x 2089mm. Max load per shelf 25kg. Weight 40.5kg.	
RACK5	RACK5 – Holds 10 balls Size: 600mm x 699mm x 1896mm. Weight 75kg.	
RACKU2	2 Shelf Universal Rack - Holds 18 balls Size: 1964mm* x 700mm x 755mm Max load: 300kg. Weight 53kg	
RACKU3	3 Shelf Universal Rack - Holds 12 balls Size: 1964mm* x 700mm x 1146mm Max load: 300kg. Weight 75.5kg	
VERTBALLs sold separately.		



VERTMINI.™

The VERTMINI is the ideal tool for getting into medball workouts, with compact sizes that make it perfect for partner exercises and mobility workouts. As well as its smaller size, an outer surface that's softer than your average medball means that users of all abilities will quickly feel confident with the VERTMINI.



COLOURS.
Vibrant colours for instant appeal.

INNER FILLING.
Cork granules, synthetic wool, treated pebbles.

OUTER COVER.
Sure grip artificial leather with polyester lining laminated with natural liquid rubber.

SMALLER SIZE.
The smaller sized VERTMINIs (203mm diameter) are ideal for kids functional fitness, and can be used one-handed by adults.

WHILST STOCKS LAST.

EVM01	1kg	VERTMINI – Green
EVM02	2kg	VERTMINI – Blue
EVM03	3kg	VERTMINI – Red
EVM04	4kg	VERTMINI – Grey
EVM05	5kg	VERTMINI – Black
TRAIN04	Medicine Balls Product Training Workshop	
RACK SPECIFICATIONS.		
RACKM5	5 Shelf Rigid Multi Rack – Holds 5 balls Size: 700mm x 700mm x 2089mm. Max load per shelf 25kg. Weight 31kg	
RACKM10	10 Shelf Rigid Multi Rack – Holds 10 balls 700mm x 700mm x 2089mm. Max load per shelf 25kg. Weight 40.5kg.	
RACK5	RACK5 – Holds 20 balls Size: 600mm x 699mm x 1896mm. Weight 75kg (as shown)	
RACKU2	2 Shelf Universal Rack - Holds 18 balls Size: 1964mm* x 700mm x 755mm Max load: 300kg. Weight 53kg	
RACKU3	3 Shelf Universal Rack - Holds 12 balls Size: 1964mm* x 700mm x 1146mm Max load: 300kg. Weight 75.5kg	
VERTMINIs sold separately.		



FUNCTIONAL.

TOTAL GRIP MEDBALL.

If you're after the fundamentals of functional fitness, look no further than this range of rubber medballs to focus on the foundational movements to build strength, power, agility and speed.

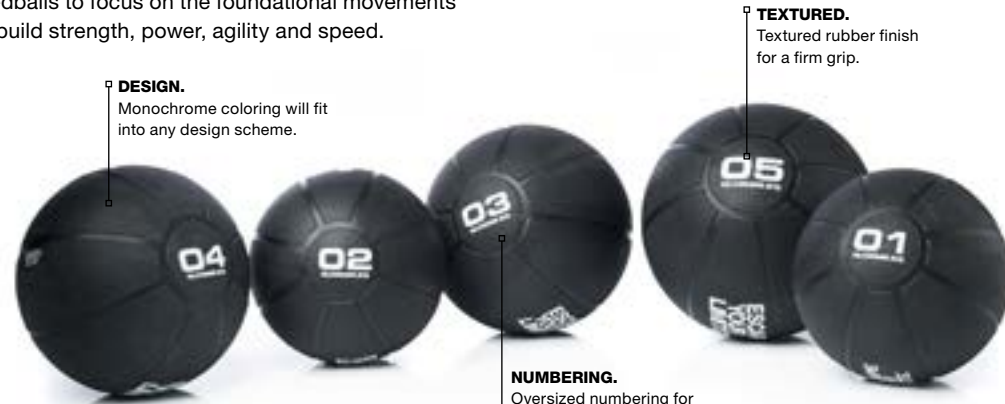

DESIGN.
Monochrome coloring will fit into any design scheme.

TEXTURED.
Textured rubber finish for a firm grip.

NUMBERING.
Oversized numbering for fast weight identification.

TGMED01	1kg	Total Grip Medicine Ball (Whilst stocks last)
TGMED02	2kg	Total Grip Medicine Ball
TGMED03	3kg	Total Grip Medicine Ball
TGMED04	4kg	Total Grip Medicine Ball
TGMED05	5kg	Total Grip Medicine Ball
TRAIN04	Medicine Balls Product Training Workshop	

MULTI GRIP MEDBALL.

Benefit from increased stability and even more workout options thanks to integrated ergonomic grip handles, offering a practical twist on the classic medball design for one or two hand holds.

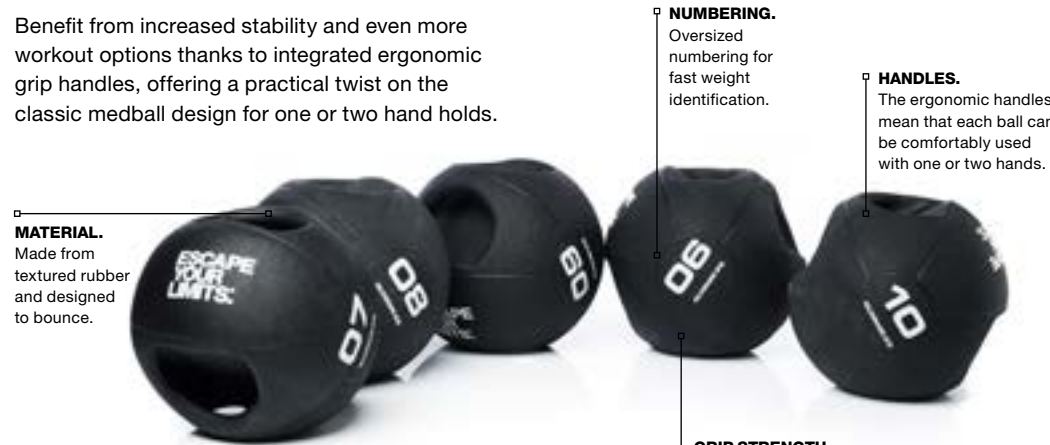

MATERIAL.
Made from textured rubber and designed to bounce.

NUMBERING.
Oversized numbering for fast weight identification.

HANDLES.
The ergonomic handles mean that each ball can be comfortably used with one or two hands.

GRIP STRENGTH.
Increased forearm strength and grip improvements both result from double grip medball training.

MGMED06	6kg	Multi Grip Medicine Ball
MGMED07	7kg	Multi Grip Medicine Ball
MGMED08	8kg	Multi Grip Medicine Ball
MGMED09	9kg	Multi Grip Medicine Ball
MGMED10	10kg	Multi Grip Medicine Ball
TRAIN04	Medicine Balls Product Training Workshop	

MULTI RACK.

Designed so that you don't have to sacrifice precious floor space for storage, our Multi Rack, in a single sided 5 or double sided 10 rack option (as shown), will utilise vertical space to safely store functional training balls off the gym or studio floor.



FUNCTIONAL.

RACK SPECIFICATIONS.

RACKM5	5 Shelf Rigid Multi Rack – Holds 5 balls Size: 700mm x 700mm x 2089mm. Max load per shelf 25kg. Weight 31kg
RACKM10	10 Shelf Rigid Multi Rack – Holds 10 balls 700mm x 700mm x 2089mm. Max load per shelf 25kg. Weight 40.5kg. (as shown)
RACK5	RACK5 – Holds 20 balls Size: 600mm x 699mm x 1896mm. Weight 75kg
RACKU2	2 Shelf Universal Rack - Holds 18 balls Size: 1964mm* x 700mm x 755mm Max load: 300kg. Weight 53kg
RACKU3	3 Shelf Universal Rack - Holds 12 balls Size: 1964mm* x 700mm x 1146mm Max load: 300kg. Weight 75.5kg

Medicine Balls sold separately.

SLAMBALL SBX.™

The SBX Slamball has had a makeover and is now tougher than ever. The new Slamball SBX delivers even more durability, so it's perfect for heavy use in workouts to build maximum power and core strength.

TEXTURED.

The combination of a 254mm diameter and textured surface makes for great handling.

SLAM.

Fight to control carefully-engineered instability and slam it as hard as you like; it won't bounce or roll, so users can really give it everything they've got.

DURABLE.

50% thicker than the previous model with a combination of SBX rubber over a reinforcing mesh fabrication.



SBSBX05	5kg	Slamball SBX – Green Number
SBSBX10	10kg	Slamball SBX – Blue Number
SBSBX15	15kg	Slamball SBX – Red Number
SBSBX20	20kg	Slamball SBX – Grey Number

TRAIN04 Medicine Balls Product Training Workshop

MULTI RACK.

Minimal footprint but maximum impact, our Multi Rack stores functional training bags vertically to retain as much workout space as possible, whilst ensuring a safe training space. Available in two options, a single sided 5 shelf (as shown) or double sided 10 shelf rack.



FUNCTIONAL.

RACK SPECIFICATIONS.

RACKM5	5 Shelf Rigid Multi Rack – Holds 5 bags Size: 700mm x 700mm x 2089mm. Max load per shelf 25kg. Weight 31kg (as shown)
RACKM10	10 Shelf Rigid Multi Rack – Holds 10 bags 700mm x 700mm x 2089mm. Max load per shelf 25kg. Weight 40.5kg.
RACK5	RACK5 – Holds 20 balls Size: 600mm x 699mm x 1896mm. Weight 75kg
RACKU2	2 Shelf Universal Rack - Holds 18 balls Size: 1964mm* x 700mm x 755mm Max load: 300kg. Weight 53kg
RACKU3	3 Shelf Universal Rack - Holds 12 balls Size: 1964mm* x 700mm x 1146mm Max load: 300kg. Weight 75.5kg

Slamball SBX sold separately.

GRIPR.®

The GRIPR is made to withstand the toughest of treatment by using micro-grade steel sand within a fully-sealed, double-stitched neoprene bag to prevent leakage. This means it's perfect for dynamic exercises, and as an effective alternative to a medball, dumbbell or kettlebell.

REGISTERED DESIGN.

DOUBLE STITCHED.

Fully-sealed, double-stitched neoprene bag to prevent leakage.

NUMBERING.

Oversized numbering for fast weight identification.

DURABLE.

Built to withstand the toughest dynamic exercises.

GRIPR202	2kg	GRIPR – Green
GRIPR204	4kg	GRIPR – Blue
GRIPR206	6kg	GRIPR – Red
GRIPR208	8kg	GRIPR – Grey
GRIPR210	10kg	GRIPR – White
GRIPR212	12kg	GRIPR – Green (whilst stocks last)
TRAIN06	GRIPR Product Training Workshop	
AMB001	Ammo Box Storage Holds 4 of each weight Size 598mm x 606mm x 835mm	

STUDIO HANDWEIGHTS.

These handweights are the perfect accompaniment to any studio. With clear colour coding for easy weight identification and an anti-roll design, these multi-purpose weights from 1kg to 5kg are great for everyone - from beginners to seasoned group X-ers.

ANTI-ROLL.

The triangular design of these weights mean they stay exactly where they are placed. There is no danger of them rolling away.

EASY-ID.

Each item is colour coded by weight, with an additional over-sized number making weight identification quick and easy.

DESIGN.

The vinyl coating is kind to studio floors whilst providing easy-grip comfort to the user.

FUNCTIONAL.

VHW21	1kg	Studio Handweight – pair – Pink
VHW22	2kg	Studio Handweight – pair – Green
VHW03	3kg	Studio Handweight – pair – Blue
VHW04	4kg	Studio Handweight – pair – Grey
VHW05	5kg	Studio Handweight – pair – Black

RACK SPECIFICATIONS.

Size: 1460mm x 530mm x 658mm. Weight 19.3kg.

Handweights not included with racks.

PRO BOUNDER.™

Specially manufactured for commercial use, the PRO BOUNDER is safe, strong and fun. It features rubber bungees in place of steel springs for a safer, smoother rebounding experience. Light enough to move around the club, but durable enough to meet the demands of a busy gym, the PRO BOUNDER adds bounce to any workout.



FRAME.
The frame of the PRO BOUNDER is an extremely strong steel tube, light enough to carry around but sturdy enough for even the most aggressive rebounding.

BUNGEEES.
Bungees provide a smoother bounce than springs and are safer for users if they get hands or feet caught within the cords.

FEET.
Rubber bumpers act as 'feet' on the legs to ensure it does not move during fast-paced workouts.

WHILST STOCKS LAST.

EST-REBOU PRO BOUNDER

SPECIFICATION.

Size: 710mm x 812mm x 937mm - frame only.
Size: 950mm x 900mm - overall size laid at flattest position.

CMT.™

The Core Momentum Trainer™, or CMT, is transforming the way people train and target the core. It's about developing deep core muscles that are difficult to reach with standard training methods. The lubricated Power Shot inside the CMT collides with the Power Core walls, and controlling this force is what kick-starts the core muscles into action.



ERGONOMICALLY DESIGNED.
Textured surface makes it easier to grip.

POWER SHOT.
The lubricated Power Shot delivers a significant force.

AUDIBLE FEEDBACK.
Combines sound with movement.

PATENTED.

- CMT1** 1kg Core Momentum Trainer – Green
- CMT2** 2kg Core Momentum Trainer – Blue
- CMT4** 4kg Core Momentum Trainer – Red

TRAIN11 CMT - Product Training Workshop

Weight refers to the internal Power Shot.

REMOVABLE HANDLES.
Create even more workout options.

WOD RINGS.

The perfect addition to any Escape Octagon frame, these gymnastic rings enable a range of exercises for all abilities.

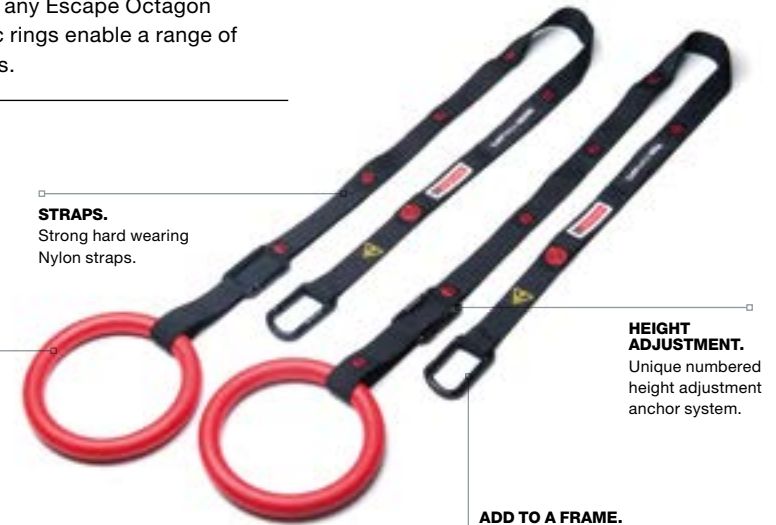

STRAPS.
Strong hard wearing Nylon straps.

RINGS.
Hard wearing moulded, textured plastic.

HEIGHT ADJUSTMENT.
Unique numbered height adjustment anchor system.

ADD TO A FRAME.
Aluminium carabiners that can be fitted to any Octagon frame.

WODRING1 WOD Ring pair

SPECIFICATION.

Size: Overall: 2235mm x 235mm Ring: 235mm (OD), 28mm (DIA).
Strap: 2000mm (L) x 40mm (W) x 1.25mm (D).

BATTLE ROPES.

Battle Rope training is one of the most underutilised exercises in fitness training. It's a tough challenge that raises the heart rate, and develops core, forearm and grip strength. Made in the UK, our ropes are built to last, with the durability to withstand the highest intensity usage.



- BR3210** 32mm Battle Rope
- BR5010** 50mm Battle Rope

TRAIN01 Battle Rope Product Training Workshop

SPECIFICATIONS.

Size approx 10m length. 32mm: Weight approx 5kg. 50mm: Weight approx 10kg. Rope diameter subject to -15% shrinkage during use.

FUNCTIONAL.

AMMO BOX.

Perfect storage for small training equipment like boxing gloves, GRIPPRs and power bands. The Ammo box is a stylish storage solution with ample capacity for most clubs.



MATERIALS.
Made from 95% carbon steel, the Ammo Box is built to take a lot of abuse in busy gyms.

SOFT CLOSE LID.
Features include gas struts for a soft-close lid.

SECURE.
Holes for padlock so you can keep your equipment safe.

EASY MOVEMENT.
The front handle and wheels make it easy to move to where people are working out.

VENTILATION.
to help complete the drying of equipment between workouts

REGISTERED DESIGN.

AMB001 Ammo Box Storage

SPECIFICATION.

Size 598mm x 606mm x 835mm. Maximum load 149kg. Equipment sold separately.

POWER BANDS.

Looking for a little help to get you started with bodyweight training? Power Bands can support members when performing pull-ups and ab rollouts, and add resistance to squats and other exercises.



- WBANDS1** Power Band 01 – Green
- WBANDM1** Power Band 02 – Blue
- WBANDL1** Power Band 03 – Red

SPECIFICATIONS.

- WBANDS1:** Width 29.8mm. Length 1m. Resistance 11kg-36kg.
- WBANDM1:** Width 44.5mm. Length 1m. Resistance 23kg-54kg.
- WBANDL1:** Width 63.5mm. Length 1m. Resistance 27kg-68kg.

FITNESS JUMP ROPE.

The ideal rope for introducing members to jump rope training. This rope is also up to the task of giving more advanced users a tool to improve coordination and raise their heart rate.



EST-ROPE5 Fitness Jump Rope - Length 2.9m.

CROSS TRAINING JUMP ROPE.

High jumping meets high performance. The ideal rope for serious cross training fans to perfect double-unders due to its roller-bearing handles and ultra-lightweight rope.



EST-ROPE3 Cross Training Jump Rope - Length 2.95m.

TRX PRO.

The TRX Pro kit is the elite, all-in-one, total body workout system designed to be the most durable suspension trainer for commercial use. It's now been upgraded with even better features, including extra padding, antimicrobial handles and adjustable anti-slip foot cradles.



TRXPRO4 TRX Pro Suspension Training Kit

Patented product. 1 year warranty.

TRX XMOUNT.

The TRX XMOUNT provides a small, sturdy anchor point for your TRX Training gear.



XMOUNT TRX XMOUNT

Patented product. 1 year warranty.

FUNCTIONAL.

RACK5.™

The RACK5 will keep your functional equipment in peak condition and your facility tidy, with plenty of options to adapt the shelves and rear storage to suit your needs.

ADJUSTABLE HEIGHT.
Shelves can be arranged to suit the unique needs of gyms and studios.

MATERIAL.
The RACK5 is made from strong carbon steel for inherent strength, and painted with a powder coat for a scratch-resistant finish.

SHELVING.
Adjustable storage shelves for a range of functional kit.



REGISTERED PATENT.

- RACK5** RACK5
 - 01. HOOPB15** Rack5 Gym Ball Holder
 - 02. MATRACKA** Rack5 Mat Rack Attachment
- Can hold up to either 65 x Yoga mats, 25 x Core mats or 25 x Flex mats.

SPECIFICATIONS.
RACK5: Size: 600mm x 699mm x 1896mm. Weight 75kg.

PLEASE NOTE: Additional storage can be ordered separately.



SHELVING.

RACK5 features integrated adjustable storage shelves for a range of functional kit. These pictures illustrate how equipment is stored on the various configurations.



RACK5 PACKS.

To save you time configuring your own equipment selection, we've assessed the demands of a functional and fitness focused workout based on our expertise, and have configured a specialized selection pack for both; Fitness or Functional, which incorporates our most popular items to specifically suit both these training needs.

- RACK5EPFU RACK5 Functional Pack**
Pack includes:
- RACK5
 - 3 x Ridge Rollers
 - 2 x 1kg and 2kg Total Grip Medballs
 - 1kg, 2kg and 4kg CMTs
 - 5kg and 10kg Corebags
 - 2 x 8kg, 12kg and 16kg Studio Kettlebells
- RACK5EPFI RACK5 Fitness Pack**
Pack includes:
- RACK5 and Mat Attachment
 - 3 x Ridge Rollers
 - 6 x Core Mats
 - 2 x 1kg and 2kg Total Grip Medballs
 - 2 x 2kg, 4kg and 6kg GRIPPRs
 - 5kg and 10kg Corebags
 - 2 x 8kg, 12kg and 16kg Studio Kettlebells



FUNCTIONAL.

BOXING.

Punch, spar and jab towards a fighting-fit body. The popularity of combat and boxing training is at an all-time high. We have continued to innovate engaging training spaces and long-lasting, durable equipment to ensure that our boxing range stands up to the wear and tear of the toughest workouts.

Boxing lends itself perfectly to group training, and can attract more interest than standard cardio and HIIT workouts. So, whether members are looking to increase their confidence or release their inner fighter, our range provides a knockout performance every time.



BOA MITTS	142
TRAINING GLOVES	143
HOOK AND JAB PADS	143
THAI BAG	144
PUNCHBAGS	146



BOA MITTS.

Pack a punch, seamlessly from start to finish, as thanks to their open-palm design, there's no need to remove these mitts when switching between bag work and handling functional training tools. They bring an authentic feel to any combat training session, but really come alive when used in a fusion of combat and functional training.



MITT001 BOA Mitt - Medium
MITT002 BOA Mitt - Large

TRAINING GLOVES.

Gloves for pad or bag work need to be specifically designed for the training environment, not the ring. That's why we created our range of combat staples. These gloves blend durability and usability; lightweight but strong, firm on the strike zone yet cushioned on the palm and fitting is quick due to Velcro wristbands.

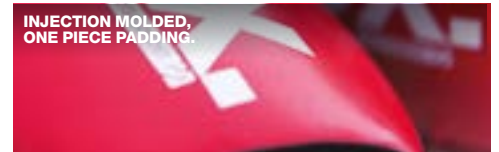

EBOX-TG10R 10oz Training Gloves – Red
EBOX-TG12B 12oz Training Gloves – Black

CURVED HOOK AND JAB PADS.

Designed to test your strike accuracy, these pads provide a target to hit and fine-tune your combinations. The dual-density palm pads, and ability to spread your hand wide to absorb punches via the individual finger placements, ensure that it's the pads that take the beating, not your hands.



EBOX-CHJP Curved Hook and Jab Pads – Pair

SPECIFICATION.
 Size 80mm x 200mm.

PERFORMANCE
EVEN FOR
THE MOST
AGGRESSIVE.



THAI BAG.

A great fit for any functional or combat-focused space, this full-length Thai bag is ideal for Muay Thai and MMA style workouts incorporating punches, kicks, elbows and knees. The stronger, more durable material straps on the Thai Bag make it much quieter than the traditional chain-strapped bags, enabling combat programs to coincide more harmoniously with other gym sessions.



DESIGN.

The bag is covered in a non-slip material, reflecting the benefits of making an impactful connection with each hit.

ANTI SWING.

There's also a loop attached to the base, enabling it to be tied securely in place.

THAIBAG1 Thai Bag

SPECIFICATION.

Size: 350mm x 1800mm. Weight 54kg.



TRAINING BAG.

This punchbag is filled in the traditional way with recycled rags and fabric to create a bag that provides a total body workout. It may be a more affordable bag, but pound for pound it still delivers a knockout performance.

DESIGN.
Simple black colouring will look good in any gym.

FILLING.
Filled the traditional way using recycled rags and fabric.



EBOX-PB Training Bag
EBOX-PBCS Training Bag Chains with one swivel

SPECIFICATIONS.
EBOX-PB: Size 350mm x 1000mm. Weight 27kg.



FREESTANDING PUNCHBAG.

This entry-level freestanding bag will challenge users of every ability without the need for permanent fixtures and fittings.

TARGETS.
Durable PVC coated polyester with two-level target zones.

DESIGN.
Monochrome design to fit into any style of fitness space.

BASE.
Moveable base for easy storage when not in use.



EBOX-FSPB2 Freestanding Punchbag
SPECIFICATION.
Size 730mm x 1830mm. Weight 72kg.

FLEXIBILITY.

To boost your all-round performance, it's important to focus first on your foundations. Work on flexibility, mobility and posture alongside every training session and your overall fitness and health will reap the benefits. Refresh tired muscles, revive key joints and condition the core with our bright, engaging range of mobility equipment, designed to help everyone get the most from every workout.



YOGA MAT	152
YOGA BLOCK AND STRAP	152
CORE MAT	154
FLEX MAT	154
MULTI MAT	156
COMBAT MAT	157
MAT RACK	158
POWER AND RESISTANCE TUBES	159
GYM BALLS	160
ROLLERS	163

MATS.

Our range of mats has been expertly designed and constructed, offering the greatest possible experience to a user – seasoned pro or absolute beginner alike. They are versatile, hard-wearing and hygienic.



COMPARISON CHART.

FEATURES	YOGA MAT.	CORE MAT.	FLEX MAT.	MULTI MAT.	COMBAT MAT.
USE	Yoga	General use, crunches, stretches, etc	Stretching, Pilates	Stretching, balance, massage, floor exercises	Judo, MMA, Combat
MATERIAL	PVC	PVC with sealed foam filling	Foam	PVC compound foam	PVC dense foam
AREA	Yoga studios	PT spaces, stretch areas	Pilates, mind/body studios	PT spaces, stretch areas	Combat spaces
SIZE	1830mm x 610mm x 4mm	1020mm x 505mm x 10mm	1840mm x 610mm x 10mm	2000mm x 1000mm x 25mm	2000mm x 1000mm x 40mm
FEATURE	Central alignment markings, sticky feel	Easy clean and wipe down, cushioning	Non-marking base, high grip	Durable but cushioned, anti-slip surface	Extra shock absorbency
EYELETS	Yes	Yes	Yes	No	No
WARRANTY	1 year	1 year	1 year	2 years	2 years

HOW TO CHOOSE.

YOGA MAT.

This mat features a centred dotted line for guidance, which makes it the ideal mat for beginners.



CORE MAT.

A hard-wearing, easy-to-clean and hygienic mat that is perfect for core conditioning within studio work.



FLEX MAT.

A high-grip, textured surface featuring a fast-acting memory foam that returns quickly to its original shape.



MULTI MAT.

PVC covering and compound foam create an easy-to-clean, versatile and comfortable mat, at home in any studio.



FLEXIBILITY.

YOGA MAT.

Our Yoga Mat is made from compact foam and has been designed to allow for more grip and comfort when performing yoga moves.

DESIGN.

The mat features a central white positioning guide for hand and feet alignment.

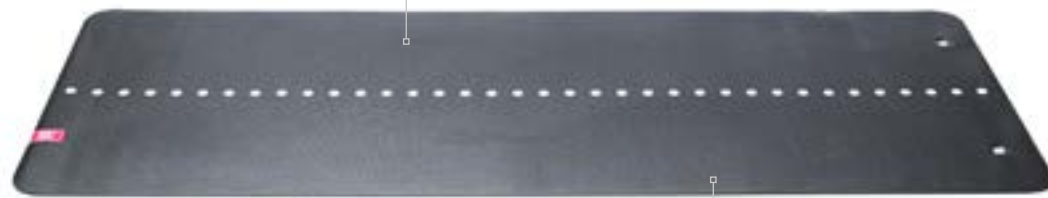

Eyelets for hanging on Escape's mat storage racks.

COMFORT.

The material used for the Yoga Mat is chosen for its excellent grip, comfort and easy-clean properties.

YMAT01 Yoga Mat – Black

SPECIFICATION.

Size: 1830mm x 610mm x 4mm.

YOGA BLOCK AND STRAP.

YOGA BLOCK.

The Yoga Block is made from high-quality foam and is heavier, stronger and will last longer than most lightweight alternatives.

YOGA STRAP.

The Yoga Strap allows users to achieve those hard-to-reach yoga positions. It will stay in place thanks to the robust buckle that securely holds the strap at the right length.



YBLOCK1 Yoga Block – Black
EST-YOGS Yoga Strap

SPECIFICATIONS.

YBLOCK1: Size: 220mm x 140mm x 75mm.

EST-YOGS: Size: 1710mm.

A YOGA MAT THAT'S READY TO GO, WHATEVER YOUR FLOW.



YOGA MAT.

YOGA BLOCK.

YOGA STRAP.

FLEXIBILITY.

CORE MAT.

Whatever your exercise needs – stretching, mind, body and balance – this specially formulated non-slip foam mat is perfect.

MATERIALS.
Welded and laminated PVC cover with foam inner.



DESIGN.
The cool anthracite color will provide your studio with a calm and relaxed atmosphere.

EST-CMATA Core Mat – Anthracite

SPECIFICATION.
Size: 1020mm x 505mm x 10mm.



Eyelets for hanging on Escape's mat storage racks.

FLEX MAT.

Two-sided, multi-purpose, non-marking base with a high-grip surface that has been designed specifically to provide extra comfort and grip, ideal for Pilates and stretching.

DESIGN.
The Flex Mat is more than three times thicker than a regular yoga mat, with a specially formulated non-slip base.



DOUBLE-SIDED.
The Flex Mat incorporates one black side, and one grey side.

MATERIALS.
Fast-reacting memory foam quickly returns to its original shape so you can work out without stopping to rearrange your mat.

EST-FMGRY Flex Mat – Anthracite

SPECIFICATION.
Size: 1840mm x 610mm x 10mm.



Eyelets for hanging on Escape's mat storage racks.

DON'T SACRIFICE ON SUBSTANCE OR STYLE. HAVE BOTH.



FLEXIBILITY.



MULTI MAT.

A large, hard-wearing stretch mat that covers the full body length. Versatile to suit most applications and durable enough to withstand daily usage.

DESIGN.
These multi-purpose mats are designed for stretching, balance, massage and light floor exercises.

MATERIALS.
The PVC covering with compound foam and polyurethane granules provides extra durability and comfort for the user.



MULTI MAT LARGE.
M0022B Multi Mat Large – Black
SPECIFICATIONS.
M0022B: Size 2000mm x 1000mm x 25mm.



COMBAT MAT.

Designed for combat sports this mat is also perfect for stretching, balance and light floor work. The ideal mat for a multitude of activities.

MATERIALS.
A PVC wipe-clean cover encases a compound foam and polyurethane centre, providing superior durability, perfect for busy studios.

EYE-CATCHING.
The bright red cover injects life and vibrancy into any training session perfect for busy studios.

ANTI-SLIP.
The slip-resistant base makes this the perfect competition mat for all kinds of combat sports from MMA, kickboxing and taekwondo to karate, judo and wrestling.



COMBAT2 Combat Mat – Red
SPECIFICATION.
Size: 2000mm x 1000mm x 40mm.

FLEXIBILITY.

SINGLE SIDED.



STORAGE.
MATRACK will store either 65 Yoga Mats, 25 Core Mats or 25 Flex Mats on each side.

MAT RACK.

Extending the Escape Rigid Rack range, the MATRACK attachment enables a dedicated space saving solution for matting.

DOUBLE SIDED.



MATRACK MATRACK - single sided
MATRACK2 MATRACK - double sided

RACK SPECIFICATIONS:
Size: H: 2089mm x W: 700mm x D: 700mm

MAT ATTACHMENTS:
Size: H: 400mm x W: 120mm x D: 353mm

WEIGHT:
Single Attachment: 23.2kg
Double Attachment: 26.2kg

POWER TUBES.



TUBES.
The elasticised tube is encased in a protective outer covering for added safety.

COLOUR CODED.
Brightly colour-coded for easy level recognition.

WHILST STOCKS LAST.

EST-PT1 Power Tube Level 01 – Pink
EST-PT2 Power Tube Level 02 – Green
EST-PT3 Power Tube Level 03 – Blue

RESISTANCE TUBES.



HANDLES.
Sure-grip handles will not get slippery during tough workouts.

COLOUR CODED.
Brightly colour-coded for easy level recognition.

EST-RTL1 Resistance Tube Level 01 – Pink
EST-RTL2 Resistance Tube Level 02 – Green
EST-RTL3 Resistance Tube Level 03 – Blue

FLEXIBILITY.

STEADYBALL PRO.™

A studio essential for balance, flexibility and strength, the Steadyball Pro is the best on the market with an unstable surface, but no sagging. Trusted to keep its rigidity, not squash and hold its shape, no matter the exercise.



BURST RESISTANT.
Burst resistant tested (brt) (349kg).

MATERIALS.
Made from PVC material and textured to provide grip from any direction.

- SBP55** 55cm/21.5" Steadyball Pro - Light Grey
- SBP65** 65cm/25" Steadyball Pro - Dark Grey
- SBP75** 75cm/28.5" Steadyball Pro - Black
- MG-33** Dual Action Pump

RACK SPECIFICATIONS:

- RACKGB3** 3 Gym Ball Rack
Size: 700mm x 933mm x 2089mm. Weight 25kg.
- RACKGB6** 6 Gym Ball Rack
Size: 700mm x 1524mm x 2089mm. Weight 29kg.
- RACKGB9** 9 Gym Ball Rack
Size: 1112mm x 1524mm x 2089mm. Weight 34kg.
- RACKGB12** 12 Gym Ball Rack
Size: 1524mm x 1524mm x 2089mm. Weight 37kg
- EST-GBSR** STAKRS Rings (whilst stocks last)

Steadyball Pro sold separately.

STORAGE.

Arranged by size, keep Steadyballs tidy with a choice of three up to 12 ball shelving options



FLEXIBILITY.



STEADYBALL™

Designed specifically for core stability and balance work. The unique, safe and stylish two tone Steadyball has self-leveling technology which means it won't roll away.

- EST-GB55** 55cm Steadyball – Purple
- EST-GB65** 65cm Steadyball – Green
- EST-GB75** 75cm Steadyball – Blue

RACK SPECIFICATIONS:

- RACKGB3** 3 Gym Ball Rack
Size: 700mm x 933mm x 2089mm. Weight 25kg.
- RACKGB6** 6 Gym Ball Rack
Size: 700mm x 1524mm x 2089mm. Weight 29kg.
- RACKGB9** 9 Gym Ball Rack
Size: 1112mm x 1524mm x 2089mm. Weight 34kg.
- RACKGB12** 12 Gym Ball Rack
Size: 1524mm x 1524mm x 2089mm. Weight 37kg

EST-GBSR STAKRS Rings (as shown - whilst stocks last)
Steadyball sold separately.



RIDGE ROLLER.

Cool looking yet brilliantly effective, the textured Ridge Roller mimics the pressure applied by a sports massage therapist's hands.

- EST-RRC** Ridge Roller
- TRAIN09** SMR Rollers Product Training Workshop
- SPECIFICATION.**
Size: 385mm x 135mm.



FLEXIBILITY.

UBERSOFT ROLLER.

This large roller is full body length, and eases muscle tension with light massage that helps beginners to achieve greater flexibility and can be used to improve balance.

- USR001** Ubersoft Roller – Grey
- SPECIFICATION.**
Size: 905mm x 150mm.



FLOORING.

Floors are the building block of every facility. When envisioning the layout and flooring of a facility, the purpose function, traffic and visual impact are all vital considerations. The right solution can transform training spaces, from incorporating engaging, zoned functional areas and highlighting speed tracks, through to identifying equipment areas or options to withstand heavy weight training. With years of experience and technical knowledge designing standout spaces, Escape provides specialist flooring for clubs that demand the best performance from their investment.

SHOCKTURF	168
SPEED TRACKS	169
CONNECT TILES	170
FLEXI-HARD	171
FLEXI-SOFT	171
EVEROLL	172
SHOCK UNDERLAY	172
EVERFLEX	173

FEATURE FLOORING.

The gym floor is unlike any other piece of equipment. It's put through its paces all day, every day so it's important not to overlook it. Clubs are increasingly looking for flooring that adds style, colour and vibrancy to the facilities aesthetic. An option that provides a resilient option that can not only withstand heavy usage but supports and protects the members, and reduces the stress placed on equipment. We've taken all of these factors into consideration to perfect a quality range of options to suit every need.

INDUSTRY-LEADING TECHNOLOGY.

The Escape flooring range will keep pace with users engaged in a variety of training styles, no matter what is thrown at it. High quality materials make it a durable, long-lasting and effective investment. Our flooring systems are designed to offer athletic benefits to end users, protecting their ankles, knees and hips in areas that may involve high impact, plyometric or aerobic training. The materials used include elastomers that adapt to the foot, reducing the risk of injury to members and instructors.

CREATING SUPERB TRAINING ENVIRONMENTS.

Escape has a range innovative, specialist flooring options for every facility's needs - from functional training, or free weight areas and studios to sports halls, sprint tracks and stretching spaces. We even offer a quality line marking service to tempt your users away from their standard training 'comfort zone' into more varied, challenging and fun programming. The right flooring solution can add an impressive 'wow' factor to clubs, transforming workout areas from uninspiring places to motivational spaces.

LET'S DELIVER YOUR PERFECT FLOORING INSTALLATION.

With several flooring options to choose from, making the right decision isn't always straightforward. That's why our team of experts are always on hand to help you choose the right product, colour and design to reflect your clubs' unique needs, considering the terms of performance and aesthetics. The team will work closely with you to assess, choose and install the flooring best suited to your club, providing an end result that ensures you stand out from the competition.

COMPARISON CHART.

FEATURES	SHOCKTURF.	SPEED TRACKS.	CUSTOMISABLE SPEED TRACKS.	FLEXI-SOFT.	FLEXI-HARD.
USE	Functional areas, SAQ, group X, performance zones, sleds/TIYRs and indoor/outdoor	SAQ areas, TIYRs, sled work, sprint tracks	SAQ areas, TIYRs, sled work, sprint tracks	Warm-up and stretch areas, yoga and Pilates	Studio areas, light functional training areas
THICKNESS	24mm	12mm	16mm	20mm	20mm
PRODUCT SIZE	Rolls from 1.25m x 10m	Portable speed tracks are 1.5m wide and available in 3 lengths - 10m, 12m and 15m. Fixed speed tracks are 1.5m wide and are available in 5 lengths - 10m, 12m, 15m, 20 and 25m.	Recommended in 2 or 4 metre wide. Lengths variable up to 35 metre	1m x 1m tile	1m x 1m tile
MATERIALS	Polyethylene and nylon	Polypropylene	Polyethylene fibres, reinforced polypropylene	EVA tiles	EVA base with a rubber top layer
COLOURS	Six base colours with white lines	Available in a range of 2 colours	Available in a range of 18 colours	Available in a range of four colours	Available in a range of four colours
RECOMMENDED INSTALLATION	DIY or professional install	DIY or professional install	DIY or professional install	DIY or professional install	DIY or professional install

FEATURES	CONNECT TILES.	FITNESS TILES.	OUTDOOR TILES.	EVERROLL CLASSIC.	SHOCK PAD UNDERLAY SYSTEM.	EVERFLEX.
USE	Functional, free weight, heavy free weight and CrossFit areas	Functional, free weight, heavy free weight and CrossFit areas	Outdoor functional, free weight, heavy free weight and CrossFit areas	Free weight, functional, main gym areas, spin studios	Functional, free weight, heavy free weight and CrossFit areas	Free weight, functional, main gym areas, spin studios, CV and resistance
THICKNESS	20mm or 40mm	15mm, 20mm or 43mm	30mm	8mm, 10mm,	10mm, 12mm, 15mm, 20mm	10mm
PRODUCT SIZE	20mm – 1m x 1m tile 40mm – 1m	15mm, 20mm or 43mm	1m x 1m tile	1.25m x 10m roll	1.25m x 10m roll	1.25m x 10m roll
MATERIALS	2mm top layer from high density epdm and SBR (1.400kg/m3), 18/38mm bottom layer from recycled tires.	100% SBR granules, bonded by PU binder	100% SBR granules, bonded by PU binder – plastic pin connectors	Recycled rubber (80%) and EPDM (20%)	Recycled rubber fibres and granules and PUR resins	Recycled rubber (80%) and EPDM (20%)
COLOURS	Black or Black with Light Grey Fleck	Black	Black	Available in a range of 6 colours	Black	Black with grey fleck
RECOMMENDED INSTALLATION	DIY or professional install	DIY or professional install	DIY or professional install	Professional install required	Professional install required	Professional install required

FLOORING.



SHOCKTURF.

This new generation synthetic turf flooring has been specifically developed for functional training environments, both indoors and outdoors. It's a reliable, heavy-duty product that has consistently performed brilliantly in wear-and-tear and resistance tests.

- STURFB** Shockturf - Black
- STURFG** Shockturf - Green
- STURFO** Shockturf - Orange
- STURFR** Shockturf - Red
- STURFS** Shockturf - Slate
- STURFT** Shockturf - Tan

SPECIFICATION.
Roll Size 40ft x 6ft.

Please contact your sales representative for a quote.
Line markings and logos are available – please call for details.

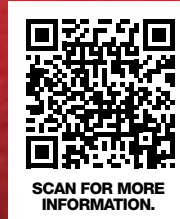

SPEED TRACKS.

Our Speed Track provides a portable or fixed flooring option perfect for agility and explosive power training, ideal for when training with the Escape TIYR and Quad Sled. Bring an outdoor feel, indoors creating an eye-catching training environment to inspire members.

SPECIFICATION.
Portable speed tracks are 1.5m wide and available in 3 lengths - 10m, 12m and 15m. Fixed speed tracks are 1.5m wide and are available in 5 lengths - 10m, 12m, 15m, 20 and 25m.
Please call for prices and installation details.



CUSTOMISABLE SPRINT TRACK.

Stand out from the crowd and bring your branding to life with our customisation options. Not only can you opt for a portable or fixed flooring solution, you can also choose from different thickness and length options. And that's not all!

With 16 colours and a variety of designs to choose from, your company logo and functional markings can be embedded seamlessly within your tiles to create a bespoke result.

Please contact our sales representative to design your customised track solution.

FLOORING.



SPECIFICATION.

Please contact our sales representative for pricing, colour options and installation details.

CONNECT TILES.

Hard wearing and long-lasting, these tiles provide protection against the continuous impact whilst absorbing noise. Easy to install, and able to be laid on top of existing floor coverings due to the unique connector system, these tiles are aesthetic and hygienic due to the near invisible joints.

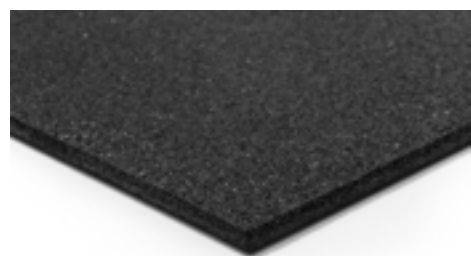

FITNESS TILES.

Highly durable and tough, the extremely dense top layer of these tiles provides sufficient impact protection against the toughest usage whilst the purpose designed bottom structure intercepts, absorbs and disperses sound and vibration as well as provides an additional protection to the sublayer or screed.

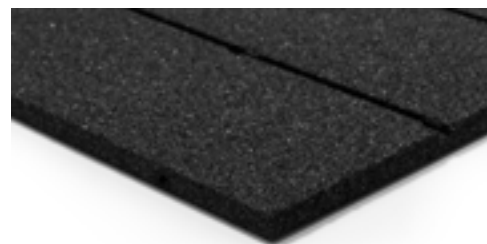

OUTDOOR TILES.

These high-impact absorbing recycled rubber fitness tiles are made and engineered for any free-weight or functional area. The two different types of bottom structures are specifically designed with strategically placed drainage channels and a pin connector system to ensure once connected, these tiles remain in place.

FLEXI-HARD.

Flexi-Hard is a durable and cushioned flooring option which is great for balance exercises, light dumbbell workouts and strength training.

USAGE.

Ideal for balance and lightweight exercises with free weights up to a maximum of 20kg.

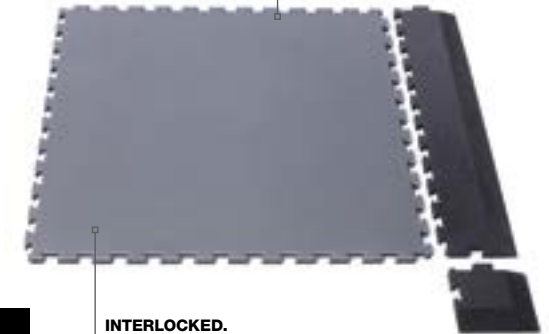

INTERLOCKED.

The tiles can be interlocked in minutes and don't need to be fixed to the floor.

AVAILABLE IN FOUR COLOURS.



- MAT510** Flexi-Hard Foam Coloured Tile
- MAT511** Flexi-Hard Foam Coloured Edge Strip
- MAT512** Flexi-Hard Foam Coloured Corner

SPECIFICATION.

- MAT510:** Size 1000mm x 1000mm x 20mm.
- MAT511:** Size 1000mm x 185mm x 20mm.
- MAT512:** Size 185mm x 185mm x 20mm.

Price is per tile and does not include fitting.

CURRENTLY UNAVAILABLE.

FLEXI-SOFT.

Flexi-Soft is a soft, slip-resistant modular flooring system which is ideal for stretching, gym balls, foam rolling and yoga studio environments.



PROTECTS.

Absorbs impact while being comfortable for stretching exercises thanks to the dense foam composition.

AVAILABLE IN FOUR COLOURS.



- MAT510S** Flexi-Soft Foam Coloured Tile
- MAT511S** Flexi-Soft Foam Coloured Edge Strip
- MAT512S** Flexi-Soft Foam Coloured Corner

SPECIFICATION.

- MAT510S:** Size 1000mm x 1000mm x 20mm.
- MAT511S:** Size 1000mm x 185mm x 20mm.
- MAT512S:** Size 185mm x 185mm x 20mm.

Price is per tile and does not include fitting.

CURRENTLY UNAVAILABLE.

EVERROLL[®] CLASSIC.

Everroll Classic is used throughout the fitness industry due to its distinctive look and feel. It also offers improved impact sound absorption, safety and comfort under foot.

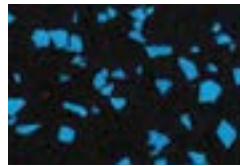

Palau

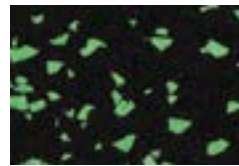

Manaus

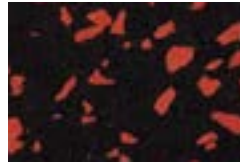

Sidon



Mons

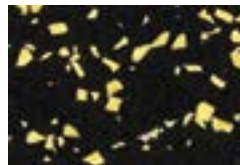

Melbourne

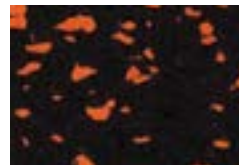

Amsterdam

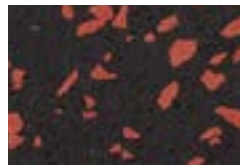

Goa

PLEASE NOTE: Colours shown here may differ slightly from the original due to the nature of the printing process. Please select your colour choice from an original sample'.

- MAT500** 8mm High Density
- MAT501** 10mm High Density
- MAT502** 12mm High Density

SPECIFICATION.
Roll Size 10m x 1.25m as standard.

SHOCK PAD UNDERLAY SYSTEM.

The Shock Pad Underlay System prolongs the quality of your gym flooring and gives maximum shock absorbency during plyometric and heavy weight training workouts.



THE SHOCK PAD SYSTEM FITS UNDERNEATH YOUR EVERROLL FLOORING.

- SP60102** 10mm Regupol Underlay – Black
- SP60122** 12mm Regupol Underlay – Black
- SP60152** 15mm Regupol Underlay – Black
- SP60202** 20mm Regupol Underlay – Black

SPECIFICATION.
Roll Size 10m x 1.25m as standard.



EVERFLEX.

Our best-selling covering. High-density and very hard-wearing, Everflex offers great insulation and shock absorption – both of which are essential properties for any facility.



- MAT600EF** Everflex 10mm High Density Matting - Grey Fleck

SPECIFICATION.
Roll Size 10m x 1.25m as standard.

TRAINING.

The key to achieving motivated members is having coaches and trainers who are knowledgeable and passionate about training tools and techniques. That's what Escape Training is here to help you achieve.



WHY ESCAPE TRAINING	176
IN CLUB GROUP PROGRAMMING	178
ONLINE TRAINING WORKSHOPS	182

TRAINING.

MEET THE TEAM OF MASTER TRAINERS.

Experience is everything, and Escape understands that we all work better together, sharing insight that we can pass on to our clients, customers, members and gym-goers. That's why we have an extensive range of training experiences, both in digital and face-to-face formats. Each one imparts knowledge about all things fitness, starting at the programming and delivering group training experience, to gamification and much more.



WHY TRAIN WITH ESCAPE.

The journey to increased revenue and retention can be so much more than just a numbers game. Escape provides an exhaustive experience in every respect, drawing on decades of knowledge for exciting workouts that bring big benefits to business and bodies alike.

Our team of Master Trainers experience this first-hand and discover ways in which they can innovate on what they learn in order to keep clients coming back for more. Join us in person or online for motivation, inspiration and perspiration through a movement revolution that we can lead together.



BUSINESS IN A BOX.

The rise of the niche-interest experiences proves that people's taste for fitness has changed. There's a growing demand for fun, fast group training, usually in a HIIT style. It's why small studios are doing so well and why established clubs often need to revisit their offering in order to compete – it's survival of the fittest.

Now any club can bring fantastic group training experiences to their members. Escape offers you a suite of programs with everything you need to get going straight out of the box, from small group training to creating a club within a club solution.



ONLINE TRAINING COURSES.

With our varied industry and evolving exercise trends, it's more important than ever to ensure your clients/members get the most engaging training experience and the very best results. Education is essential – upskill with Escape.

This system of training supports PTs within gyms, running their own facilities, or taking on the world outside a traditional gym in spaces such as boot camps. The tools provided can be successfully used to stay ahead in business and in fitness.



INSTRUCTOR TRAINING.

Becoming certified is essential for companies and trainers aiming for the highest level of member experience. Our certification courses are designed to give you the how and why behind training methods, so that trainers gain the confidence to work with any member.

The importance of in-depth research, practical knowledge and real experience are paramount to the way we create our courses. This is why we create the very best course content and support that allows you to deliver the best training to members.



MOVE IT.

MOVE IT.[®] GROUP TRAINING PROGRAMME.

MOVE IT is designed to achieve the maximal post exercise benefits of HIIT training, developing rest aerobic and anaerobic capacity to new levels. Participants move through a series of workout zones, with intervals, equipment and exercises carefully chosen to challenge energy systems while developing total body, functional strength and endurance.

WHAT DO MEMBERS GET FROM MOVE IT?

MOVE IT provides a fun, challenging, self-paced workout for members of most fitness levels. It has been designed from the ground up in a way that lets people of different capabilities work out together.

The typical MOVE IT participant will be looking for more variety and fun – and better results – than they can get from other workouts. It's the combination of the HIIT approach and the group format that packs such a punch. This leads on to much greater engagement with the club or trainer and a long-term commitment to their fitness journey.

WHAT TYPE OF CLUB IS IT FOR?

Developed to have mass-appeal, this programme is a brilliant way for larger clubs to engage more members than ever in functional training. It turns part of the gym floor into a dynamic, exciting group training space. Smaller group training studios can also achieve results with MOVE IT by integrating it as a key area of programming.

THE PACKAGE.

Here's what you get in your MOVE IT package:

- Programme Principles Manual (binder and online pdf).
- How-to Guide (binder and online pdf).
- Exercise library per workshop (course videos with coaching notes).
- **24** workouts of 30 minutes (course videos with coaching notes).
- **24** workouts of 45 minutes (course videos with coaching notes).
- Warm-up and cool down exercises (course videos with coaching notes).
- **28** bonus workouts (templates with coaching notes).
- **6** fitness tests (templates with coaching notes).
- **7** product training workshops (online access to workshop material including course videos).
- Marketing material (posters, flyers and social media content for you to use).

MIB001 MOVE IT Training Program

MIB100 Additional face-to-face training
- two day course (can only be purchased with MIB001)

Additional face-to-face product training workshops:

- Kettlebell
- Corebag
- Bulgarian Bag
- GRIPR
- CMT
- SMR with Foam Rollers

Face-to-face Product Training Workshops - please contact your sales representative for a quote.



MOVE IT EQUIPMENT PACKS.

MIBEP12 Up to 12 users – MOVE IT Equipment Pack

- x10 Adjustable Hurdles
- x6 CMTs
- x6 GRIPRs
- x2 Ridge Rollers
- x6 Slamball SBX
- x2 Speed Ladders
- x2 Suspension Trainer **(ordered separately)**
- x14 Corebags
- x8 Fitness Bulgarian Bags
- x6 Multi-Grip Medballs
- x10 SBX Kettlebells
- x1 Ammo Box

MIBEP18 13-18 users – MOVE IT Equipment Pack

- x10 Adjustable Hurdles
- x9 CMTs
- x9 GRIPRs
- x2 Ridge Rollers
- x8 Slamball SBX
- x2 Speed Ladders
- x3 Suspension Trainer **(ordered separately)**
- x20 Corebags
- x12 Fitness Bulgarian Bags
- x8 Multi-Grip Medballs
- x15 SBX Kettlebells
- x1 Ammo Box

MIBEP30 19-30 users – MOVE IT Equipment Pack

- x10 Adjustable Hurdles
- x12 CMTs
- x12 GRIPRs
- x2 Ridge Rollers
- x12 Slamball SBX
- x4 Speed Ladders
- x4 Suspension Trainer **(ordered separately)**
- x28 Corebags
- x12 Fitness Bulgarian Bags
- x12 Multi-Grip Medballs
- x20 SBX Kettlebells
- x1 Ammo Box

PLEASE NOTE: A Suspension trainer is essential for MOVE IT. Suspension Trainers must be ordered separately.

READY TO HIIT YOUR WHOLE BODY?



**HIIT
THE
DECK.**
escape

HIIT THE DECK. GROUP TRAINING PROGRAMME.

Imagine a large group or a compact boutique studio space, full of people moving quickly between step routines, plyometric jumps, resistance band work and bench presses. Using just the Escape Deck 2.0 and a handful of other carefully-chosen tools, we've created a programme package that makes it possible.

WHAT DO MEMBERS GET FROM HIIT THE DECK?

HIIT THE DECK works superbly as an introduction to functional training for members who have had limited exposure to it so far. It includes exercises and workouts embracing cardio, strength and plyometrics, giving people a fantastic whole body experience. Instructors can also ramp up the intensity for more advanced members. The pace and resistance levels can be increased according to participant fitness levels: there is no limit on the amount of challenge that can be achieved with HIIT THE DECK.

WHAT TYPE OF CLUB IS IT FOR?

Thanks to its suitability for members of almost all abilities, this is an incredibly flexible solution that includes programming for PTs, standalone small group studios and boutiques, and large group studio spaces. It can be run as one of several programs in a club, but the sheer scale and variety of workouts means it also has the potential to be used as the basis for a club's entire programming.

WHAT'S INCLUDED?

There are instruction manuals for trainers, 45-minute large group workouts (and the music to go with them), 20-minute small group workouts, one-to-one PT workouts, specialist boutique workouts and an exercise library covering all of the workout components.

THE PACKAGE.

Here's what you get in your HIIT THE DECK package:

- Training and operations manual (binder and online pdf).
- Exercise library per workshop (course videos with coaching notes).
- **6** exercise-to-music workouts of 45 minutes for large group programming (course videos, coaching notes and ready-to-download music).
- **10** workouts of 20 minutes for small group programming (course videos with coaching notes).
- **6** workouts for personal training (course videos with coaching notes).
- **128** specialist boutique studio workout interval protocols covering lower, upper, core and total body (course videos with coaching notes).
- The Deck Time Trial (video and template document).
- Marketing material (posters, flyers and social media content for you to use).

HTD001 HIIT THE DECK Training Programme

HTD100 HIIT THE DECK face-to-face training - one day course (can only be purchased with HTD001)

Additional face-to-face product training workshops:

- Bulgarian Bag
- DECK 2.0
- GRIPR

Face-to-face Product Training Workshops - please contact your sales representative for a quote.



HIIT THE DECK CLUB EQUIPMENT PACKS - PER PERSON

HTDBEB1 Beginner Pack

- x1 DECK
- x1 Resistance Tube Level 2
- x2 2.5kg Urethane Dumbbells
- x2 7.5kg Urethane Dumbbells
- x2 4kg GRIPR
- x1 5kg Bulgarian Bag

HTDBEA1 Advanced Pack

- x1 DECK
- x1 Resistance Tube Level 3
- x2 10kg Urethane Dumbbells
- x2 15kg Urethane Dumbbells
- x2 6kg GRIPR
- x1 8kg Bulgarian Bag

PLEASE NOTE: One pack is required per participant in a class.

PRODUCT TRAINING WORKSHOPS.

Trainers and coaches can develop comprehensive skills and knowledge with our product training workshops. Each workshop includes video demonstrations of multiple exercises, created by Escape's Master Trainers. It's like having product experts deliver one-to-one instruction, but with the convenience of online delivery.

In addition to the online delivery format, we also run two-hour product training workshops in clubs for groups of trainers. Clubs typically purchase three or four workshops (covering different products) to run on the same day. Participants in the in-club workshops also enjoy full access to the online support materials.



TRAIN01	Battle Rope - product training workshop
TRAIN02	Bulgarian Bag - product training workshop
TRAIN03	Kettlebell - product training workshop
TRAIN04	Medicine Balls - product training workshop
TRAIN05	TIYR - product training workshop
TRAIN06	GRIPR - product training workshop
TRAIN07	Plyometrics - product training workshop
TRAIN08	Corebag - product training workshop
TRAIN09	SMR Rollers - product training workshop
TRAIN10	Sandbag - product training workshop
TRAIN11	CMT - product training workshop
TRAIN12	DECK 2.0 -product training workshop

Face-to-face product training workshops - only available in packs:

- PTB3PACK** Product training workshop - 3 pack
- PTB4PACK** Product training workshop - 4 pack

Face-to-face Product Training Workshops - please contact your sales representative for a quote.

MASTER ANY MOVEMENT.



FIND YOUR NICHE.

More and more fitness spaces are finding a niche and servicing specific interests of clients; the same goes for entrepreneurial personal trainers, too. With Escape product training, you can pick exactly what you want to master, and become a pro with any performance tool.

ACCESS ANYWHERE.

Escape Training leads the way in functional training methods and provides you with real world, practical tools to use instantly. Through Escape training, you can also access our PT Live seminars, where you can learn from industry leaders wherever you are.

FOR GYM OWNERS OR GO-IT-ALONERS.

These are the perfect workshops to empower a PT to deliver exciting training sessions to their clients. These workshops also ensure that club owners purchasing the equipment can enable their trainers to teach safe use of it and maintain it correctly.

INDEX.

A

Adjustable Bench56
Adjustable Hurdle111
Agility Grid System111
AMMO Box136
App, Escape Your Limits07
Attachments, Octagon93, 95, 100

B

Bags
Boxing144-147
Bulgarian Bags, Fitness119
Corebags120
Freestanding Punchbag147
Storage Racks121
Thai145
Training146

Balls

ENDURA125
Gym160, 162
Medicine Balls122-131
Multi Grip128
Slamball SBX130
Steadyball Pro160
Steadyball162
Storage Racks125-131
Total Grip128
VERTBALL126
VERTMINI127
Bands, Power136

Barbells

Curl, Urethane32
Fixed, Urethane32
Storage and Sets33

Bar Holder, Olympic

Bars

Curl49
Junior49
Power49
Storage52
WOD49
Barrow107
Battle Ropes135
BASE BENCH95
BASE STATION53
Before You Order186-187
Bench, Adjustable56
Black, Plyoboxes116
Block and Strap, Yoga152
BOA Mitts142
BOA Rail, Octagon90

Boxes

AMMO Box136
GLUTE BOX113
Multiplyo115
Plyosoft Boxes114-116
STRONGBOX54
Boxing140-147
BOA Mitts142
BOA Rail, Octagon90
Boxing Frames, Octagon70-71, 88-91
Freestanding Punchbag147
Pads, Curved Hook and Jab143
Punchbags144-147
Thai Bag145
Training Bag146
Training Gloves143
Bulgarian Bags, Fitness119
Bumper Plates
Elite Urethane44
Rubber45
Business in a Box176-181

C

Clamp Collar, Olympic52
CMT, Core Momentum Trainer134
Collars
Olympic Clamp Collar52
Olympic Spring52
WOD52
Colour Options, Octagon102-103
Coloured, Plyoboxes114
Combat Mat157
Competition Pro Kettlebells 2.036
Connect Tiles170
Core Mat154
Corebags120
Corner Storage, Octagon79
Cross Training Jump Rope137
CRUX Rope Pulley93
Curl Bar49
Curled Barbells32-33
Curved Hook and Jab Pads143
Customisable Sprint Track169
Customisation, Octagon96-103

D

DECK 2.057
Designed to Order, Octagon96-103
Digital06-15
Dumbbells20-31
Dumbbell and Kettlebell Sets
with Rack39
Dumbbells with STRONGBOX54
Nucleus22-23, 28-31, 39
SBX23
STAKRBELL25
Storage Racks and Sets26-31
Urethane22, 28-30

E

Education, Escape Training174-183
Elite Urethane Bumper Plates44
ENDURA Ball125
Escape Your Limits App07
Escape Your Limits Podcast06
Everflex Flooring173
Evergreen Eco Rep Set46
Evergreen Urethane
Grip Plates42
Evergreen Plates42, 46
Everroll Flooring172

F

Fitness Bulgarian Bags119
Fitness Jump Rope137
Fitness Pack – RACK5139
Fitness Tiles170
Fixed Barbells32-33
Flexibility148-163
Flooring164-173
Connect Tiles170
Customisable Speed Track169
Everflex173
Everroll172
Fitness Tiles170
Flexi-Hard171
Flexi-Soft171
Lift Platforms51
Outdoor Tiles170
Shock Pad Underlay System172
Shockturf168
Speed Track, Portable169
Flex Mat154
Flexi-Hard Flooring171
Flexi-Soft Flooring171
Frames60-103
Attachments93, 95, 100
BASE BENCH95
BOA Rail90
Boxing91
Colour Options102-103
Corner79
MATRACK158
Designed to Order96-103
Freestanding70-73, 77, 79, 81, 84, 86

G

Gloves, Training143
GLUTE BOX113
Grip Plates, Evergreen Urethane42
Grip Plates, Rubber42
GRIPR132
Group Training Programs178-181
Gym Balls
Holder, RACK5139
Steadyball162
Steadyball Pro160
Storage139, 160-162

H

Half Box, Octagon83
Half Squad, Octagon86
Handweights, Studio133
HIIT THE DECK Group Training Program181
HIT HUB Frames, Octagon66-73
HIT HUBS66-73
Hook and Jab Pads, Curved143
HTS 90, Octagon79
HTS Frames, Octagon74-79
Hurdles111

I

Instructor Training176-183
Integrated Lift Platforms51

J

Junior Bar49
Jump Ropes137

K

Kettlebells34-39
Competition Pro 2.036
Kettlebell and Dumbbell Sets
with Rack39
SBX37, 39
Storage Racks and Sets36-39
Studio38

L

Lateral Endurance Hurdle111
Lift Platforms51
Freestanding51
Integrated51

M

MARS Screens08-15
Functional11
Recovery15
Strength13, 30
Corner158
MATRACK158
Mats150-158
Combat157

Freestanding MONO86
Freestanding Squat Hub84
Half Box83
Half Squad86
HIT HUBS66-73
HTS74-79
HTS 9078-79
Octagon81
QUAD85
Squat82-85
T1 Tower64-65
WOD Box83

Free Weights18-47
Freestanding
Frames70-73, 77, 79, 81, 84, 86
Freestanding Lift Platforms51
Freestanding MONO86
Freestanding Punchbag147
Freestanding Squat Hub84
Functional104-139
Functional Pack – RACK5139
Functional Screen, MARS11

N

Nucleus
Barbells32-33
Dumbbells22-23, 28-31, 39
Grip Plates42
Kettlebells37, 39

O

Octagon Frame81
Octagon Frame Range60-103
Attachments93, 95, 100
BASE BENCH95
BOA Rail90
Boxing70-71, 90-91
Colour Options102-103
CRUX Rope Pulley93
Designed to Order96-103
Freestanding70-73, 77, 79, 81, 84, 86
Freestanding MONO86
Freestanding Squat Hub84
Half Box83
Half Squad86
HIT HUB66-73
HTS74-79
HTS 9079
Octagon81
QUAD85
Squat82-87
T1 Tower64-65
Wall Based68-73
WOD Box83
Olympic Bar Holder52
Olympic Clamp Collar52
Olympic Spring Collar52
Online Product Training Workshops182
Outdoor Tiles170

P

Pads, Curved Hook and Jab143
Plates40-47
Elite Urethane Bumper44
Evergreen Eco Rep Set46
Evergreen Urethane Grip42
Rubber Bumper45
Rubber Grip42
Sets with Weight Tree43
Storage43-45, 47
Platforms
DECK 2.057
Lift Platforms51
STEP and RISER58-59
Plyosoft Boxes114-117
Podcast, Escape Your Limits06
Portable Speed Track169
Power Bands136
Power Bar49
Power Tubes159

PRO BOUNDER

Product Training Workshops182
Pulley, CRUX93
Punchbag, Freestanding147
Punchbags144-147

Q

Quad Sled110
QUAD, Octagon85

R

RACK511, 15, 127, 138-139
Gym Ball Holder139
Mat Attachment138
Product Packs139
Shelving139
Racks and Storage
AMMO Box136
Barbell33
Bars52
Dumbbell28-31, 39, 57
Gym Ball139, 160-162
Kettlebells36-39
MATRACK158
Medball Racks125-131
Multi Use Racks, Rigid121, 129, 131
Racks and Storage
AMMO Box136
Barbell33
Bars52
Dumbbell28-31, 39, 57
Gym Ball139, 160-162
Kettlebells36-39
MATRACK158
Medball Racks125-131
Multi Use Racks, Rigid121, 129, 131
Plates43-47
RACK5138-139
Rep Set46-47
Toast Rack44-45
Weight Tree43
Recovery Screen, MARS13
Rep Set, Evergreen Eco46
Resistance Tubes159
Rigid Storage Racks
Barbell33
Bars52
Dumbbell Racks28-31, 39
Kettlebell36-39
MATRACK158
Multi Use121-129, 131
Rep Set47
Vertical Dumbbell Rack28
Weight Tree43
XRACK 2.013, 29, 30
Ridge Roller163
Rings, STAKR162
Rings, WOD135
RISER59
Roller, Ubersoft163
Rollers163
Rope Pulley, CRUX93
Ropes
Rope, Battle135
Rope, Cross Training137
Rope, Jump137
Rope Pulley, CRUX93
Rubber Bumper Plates45
Rubber Grip Plates42

S

SBX Dumbbells23
SBX Kettlebells37, 39
SBX, Slamball130
Shelving, RACK5139
Shock Pad Underlay System172
Shockturf168
Slamball SBX130
Sled, Quad110
Speed Cones111
Speed Ladder111
Speed Track169
Speed Track, Portable169
Speed Training
Adjustable Hurdle111
Agility Grid System111
Lateral Endurance Hurdle111
Speed Cones111

Speed Ladder111
Spring Collar, Olympic52
Sprint Track, Customisable169
Squat Frames, Octagon82-87
Squat Hub, Freestanding, Octagon84
STAKR Rings162
STAKRBELL24-25
Steadyball162
Steadyball Pro160
STEP and RISER58-59
Storage Racks and Sets, Dumbbells26-31, 39
Storage Racks and Sets, Kettlebells34-39
Storage Racks and Sets, Plates43-47
Storage Racks, Rigid13, 28-33, 36-39, 43, 52, 121-129
Strap and Yoga Block152
Strength16-59
Strength Screen, MARS13, 30
STRONGBOX54
Studio Handweights133
Studio Kettlebells38

T

T1 Tower64-65
Terms and Conditions188-190
Thai Bag145
Tiles, Connect170
Tiles, Fitness170
Tiles, Outdoor170
TIYR109
Toast Rack44-45
Total Grip Medball128
Training174-183
Training Bag146
Training Gloves143
Training, Escape Education174-183
TRX Pro137
TRX XMOUNT137
Tubes, Power159
Tubes, Resistance159

U

Ubersoft Roller163
Urethane Barbells32-33
Urethane Dumbbells22, 28-31
Urethane Elite Bumper Plates44
Urethane Evergreen Eco Rep Set46
Urethane Evergreen Grip Plates42

V

VERTBALL126
Vertical Dumbbell Rack28
VERTMINI127

W

Wall Based Frames66-73
Warranties191
Weight Tree43
WOD Bar49
WOD Box, Octagon83
WOD Collar52
WOD Rings135
Workout App07
Workout Screen08-15

X

XMOUNT TRX137
XRACK29, 30
XRACK with MARS Strength Screen13, 30

Y

Yoga Block and Strap152
Yoga Mat152

Z

Core154
Flex154
Multi156
Storage and Rack158
Yoga152

Medballs122-131
ENDURA Ball125
Multi Grip128
Slamball SBX130
Storage125-131
Total Grip128
VERTBALL126
VERTMINI127
Mitts, BOA142
MONO, Freestanding Octagon86
MOVE IT Group Training Program179
Multi Grip Medballs128
Multi Mat156
Multi Use Racks, Rigid121, 129, 131
Multiplyo115

PRO BOUNDER

Product Training Workshops182
Pulley, CRUX93
Punchbag, Freestanding147
Punchbags144-147

Q

Quad Sled110
QUAD, Octagon85

R

RACK511, 15, 127, 138-139
Gym Ball Holder139
Mat Attachment138
Product Packs139
Shelving139
Racks and Storage
AMMO Box136
Barbell33
Bars52
Dumbbell28-31, 39, 57
Gym Ball139, 160-162
Kettlebells36-39
MATRACK158
Medball Racks125-131
Multi Use Racks, Rigid121, 129, 131
Racks and Storage
AMMO Box136
Barbell33
Bars52
Dumbbell28-31, 39, 57
Gym Ball139, 160-162
Kettlebells36-39
MATRACK158
Medball Racks125-131
Multi Use Racks, Rigid121, 129, 131
Plates43-47
RACK5138-139
Rep Set46-47
Toast Rack44-45
Weight Tree43
Recovery Screen, MARS13
Rep Set, Evergreen Eco46
Resistance Tubes159
Rigid Storage Racks
Barbell33
Bars52
Dumbbell Racks28-31, 39
Kettlebell36-39
MATRACK158
Multi Use121-129, 131
Rep Set47
Vertical Dumbbell Rack28
Weight Tree43
XRACK 2.013, 29, 30
Ridge Roller163
Rings, STAKR162
Rings, WOD135
RISER59
Roller, Ubersoft163
Rollers163
Rope Pulley, CRUX93
Ropes
Rope, Battle135
Rope, Cross Training137
Rope, Jump137
Rope Pulley, CRUX93
Rubber Bumper Plates45
Rubber Grip Plates42

S

SBX Dumbbells23
SBX Kettlebells37, 39
SBX, Slamball130
Shelving, RACK5139
Shock Pad Underlay System172
Shockturf168
Slamball SBX130
Sled, Quad110
Speed Cones111
Speed Ladder111
Speed Track169
Speed Track, Portable169
Speed Training
Adjustable Hurdle111
Agility Grid System111
Lateral Endurance Hurdle111
Speed Cones111

BEFORE YOU ORDER.

As exclusive Business to Business suppliers of Fitness Equipment to the Industry, Escape Fitness aims to make the Customer buying experience efficient and informative. Orders placed with Escape Fitness are subject to the standard Terms and Conditions of Business ("Conditions") contained in the following pages to the exclusion of any other terms or conditions that the Customer seeks to impose or incorporate or that may be implied by trade custom, practice or course of dealing. In the event that Goods are sold on to a third party, it is the Customer's responsibility to ensure the ultimate purchaser is fully acquainted with, and accepts the Conditions overleaf. No variation of these Conditions shall be effective unless expressly agreed in writing by an Escape Fitness authorised signatory.

THINGS TO NOTE BEFORE ORDERING.

Delivery charges

The cost of delivery depends on volume and weight. Please contact Escape or your local representative for details.

UK delivery

Most Orders will be delivered as parcels by independent carriers. Where large Orders cannot be delivered as parcels, the Order will be delivered on pallets to the exterior access point of the delivery address (UK Mainland Only.) The Customer must provide adequate manpower to unload the Goods and dispose of all packaging supplied for transit. Escape Fitness offer an Upgraded Delivery Service which includes a two-man team who will deliver, unload, assemble and site the Goods, removing all transit packaging upon completion. Please call for an Estimate.

Overseas delivery

Most small items will be sent as parcels by independent carriers. Larger items may be delivered by a dedicated specialist shipping company. Certain stock items may be dispatched from Escape Fitness's warehouses in Germany or Thailand. Please call for an Estimate.

Product assembly and installation

Please note that functional frames and equipment storage racks will require assembly after delivery. Escape Fitness offers an installation service to include the assembly of and safe siting of equipment. Please call for an Estimate.

Customised, bespoke and made-to-order products

Once an Order has been placed and an Order Confirmation issued in respect of Goods that are customised, bespoke or special order, it cannot be amended or cancelled. Goods are customised when an element of the product is changed e.g. the Customer's brand colour or logo is added. Bespoke Goods are specifically designed for the Customer and include, but are not limited to, flooring, functional frames and storage solutions. Special order Goods include products that are not normally held in stock or are ordered in a large quantity e.g. MARS, storage racks etc. Escape Fitness do not accept any liability for loss or damage incurred or suffered by the Customer as a result of inaccuracies made by them in the Order process. Accurate measuring is essential. To avoid the possibility of mistakes, use Escape Fitness's site survey service (see following details).

MEASURING AND SURVEYS.

When ordering large/heavy equipment or flooring, it is important that accurate measurements of the relevant area are supplied to ensure equipment will fit and can be used safely. Accurately measuring access points, corridors, lifts, stairs, and their height is equally important to ensure smooth delivery and installation. Escape Fitness offers a free site survey for those Customers who place an Order for both Goods and installation (expressed as a credit on the final invoice). The survey takes account of all these factors as well as the suitability of the product for a particular location. This service is also available for 'supply only' orders at a cost of £150+ VAT.

DAMAGES AND DELIVERY DISCREPANCIES.

All deliveries must be checked as soon as received and before the delivery note is signed as any discrepancy or damage in the consignment must be notified to Escape Fitness immediately, and within 48 hours at the latest. Please note the time of delivery as recorded on the delivery note. If a discrepancy is identified, the Customer should telephone Escape Fitness's Customer Services Department free on 01733 313535 with full details of the Goods ordered and the damage or discrepancy identified. At its sole discretion, Escape Fitness will either replace or repair the Goods. Reports of damage or discrepancy will not be entertained after the expiration of 48 hours from the time of delivery as recorded on the delivery note or similar device operated by the carrier.

CANCELLATIONS AND RETURNS (NOT APPLICABLE TO CUSTOMISED, BESPOKE AND SPECIAL ORDER GOODS).

Once a quotation is accepted by the Customer placing an Order, Escape Fitness will issue an order confirmation. The customer may amend or cancel the Order within 14 days of the Order confirmation and provided the Order has not been dispatched. A fee of 10% of the Order value (net of VAT) will be charged to cover administration costs. Escape Fitness reserves the right to reduce the above fee, in its sole discretion when the amendment sought by the Customer is de minimis or there are other exceptional circumstances justifying the same.

Where Goods have been dispatched, the Customer may return some or all of the Goods for up to 14 days after receipt (as recorded by the carrier) provided that the goods are returned to the supplier at the Customer's cost and in new and unused condition with all the original labels and packaging intact. A fee of 20% of the Order value (net of VAT) will be charged to cover administration and stock handling costs. Goods may not be returned unless a returns reference number has been issued by Escape Fitness's Customer Service Department.

NON-RETURNABLE ITEMS.

Unless Goods are damaged or faulty, any customised, bespoke, made-to-measure order equipment or flooring cannot be returned once an Order for confirmation has been issued. Items such as floor mats, gloves, mitts etc cannot be returned once dispatched for hygiene reasons.

PRODUCT MEASUREMENTS.

All sizes, weights and measurements are approximate. All products in Escape Fitness's functional range are subject to a tolerance of up to +/- 20%.

UK SALES.

For UK sales direct from Escape please contact us as follows:

1. **Telephone:** +44 1733 313535
2. **Website:** www.escapefitness.com
3. **Email:** sales@escapefitness.com
4. **Post:** Eastwood House, The Office Village, Cygnet Park, Hampton, Peterborough, PE7 8FD.

When placing an order by post or email, the Customer should:

1. Quote the product code, product description, quantity required, price, VAT and carriage costs.
2. Include their unique purchase order number (for account customers this must have been authorised by an appropriate signatory).
3. Print the name, department and position of the person placing the order.
4. Confirm the method of payment.
5. Provide the full postal delivery address.

NB Customers' purchase orders are only accepted from pre-approved Customers or account holders.

PAYMENT.

Customers may use the credit/debit cards shown.



Card payments are required for orders from non-account Customers.

NON UK SALES.

Please contact your local distributor for information on pricing and how to place your order.

FEEDBACK.

Escape Fitness believes in continuously improving its products and services. It can only do this by listening to its Customers. If you have a comment to make please contact Escape Fitness's Customer Services Team on:

Telephone: 01733 313 535

Email: aftersales@escapefitness.com

Or alternatively write to:

Customer Services Department, Escape Fitness Limited, Units 11-14 Tresham Road, Orton Southgate, Peterborough, Cambridgeshire, PE2 6SG.

TERMS AND CONDITIONS.

1. THE CONTRACT.

- 1.1 In these Terms and Conditions ("Conditions"), Escape Fitness Limited or one of its group of companies, is the Supplier and you are the Customer.
- 1.2 Upon receipt of a written Quotation, accompanied by these Conditions, (and where design and/or installation is requested; a Programme of Works), the Customer may offer to purchase the Goods and/or Services by signing, dating and returning the copy of these Conditions supplied with the Estimate or Quotation to the Supplier, or by submitting a purchase order. The Supplier will accept the offer by sending to the Customer an Order Confirmation at which time a binding contract will exist between the parties and the Customer may not amend or cancel the Order without the Supplier's written consent. The Customer is responsible for ensuring that the details set out on the estimate or quotation are complete and accurate.
- 1.3 The Customer acknowledges that it has not relied on any statement, promise or representation made, or given by or on behalf of, the Supplier which is not set out in these Conditions. Any samples, drawings, descriptive matter or advertising issued by the Supplier and any descriptions or illustrations of the Goods or Services contained in catalogues or brochures are issued or published for the sole purpose of giving an approximate idea of the Goods and Services described in them. They do not form part of the Contract nor have any contractual force. These Conditions apply to the Contract to the exclusion of any other terms that the Customer seeks to impose or incorporate, or which are implied by trade custom, practice or course of dealing. Where the Customer re-sells the Goods, it is the Customer's responsibility to ensure the ultimate purchaser is fully acquainted with, and accepts these Conditions. No variation of these Conditions shall be effective unless expressly agreed in writing by the Suppliers authorised signatory.
- 1.4 These Conditions apply to the supply of both Goods and Services except where application to one or the other is specified.
- 1.5 The Supplier reserves the right to change these Conditions at any time. The amended Conditions will take effect on the 30th day following the date upon which the amended Conditions are sent to the Customer. The placing of further Orders after the amendment date and before the effective date shall signify the Customer's acceptance to be bound by the latest Conditions.

2. PRICE & PAYMENT.

- 2.1 The price of the Goods and Services shall be the price set out in the Estimate or Quotation (the latter of which shall be valid for 30 days) or the price stated in any effective Supply Agreement. Prices are quoted net of VAT. VAT is payable by the Customer at the prevailing rate as indicated upon the Estimate, Quotation or Pro-Forma Invoice. Prices are subject to change on not less than 30 days notice.
- 2.2 Payment for the Goods and Services shall be made in full at the time the Order is placed to the Supplier's bank account detailed in the Quotation. For Customers who have a credit account with a sufficient credit limit, Goods shall be paid for in accordance with their credit account terms. Time for payment shall be of the essence of the Contract. VAT Invoices are issued when the Goods are dispatched.
- 2.3 Interest is payable to the Supplier on overdue amounts at the rate of 4% per annum above Barclay's Bank base rate accruing on a daily basis from the due date until the date of actual payment of the overdue amount.
- 2.4 The Customer shall pay all amounts due under the Contract in full without any deduction or withholding except as required by law and the Customer shall not be entitled to assert any credit, set-off or counterclaim against the Supplier in order to justify withholding payment of any such amount in whole or in part.

3. GOODS AND SERVICES.

Orders are accepted for Goods and Services by the Supplier strictly subject to availability and to these Conditions.

4. CUSTOMISED, BESPOKE AND MADE-TO-ORDER GOODS.

- 4.1 In respect of any Order for customised, bespoke or special order Goods (flooring, frames, the MARS, racks, etc), the Customer may not amend or cancel an Order once accepted (including positioning of equipment where installation is involved). It is imperative that all Customer requirements are fully and accurately conveyed to the Supplier prior to acceptance of the Order. The Supplier accepts no liability for costs, expenses, damages and losses (including any direct, indirect or consequential losses) suffered or incurred by the Customer or any sub-contractor, agent or third party employed by the Customer arising out of any delay in delivery or installation of the Goods where such delay is caused by inaccuracies of whatever nature in the Customers Order. To avoid such inaccuracies, the Supplier recommends a site survey of the installation premises. Surveys cost £150 + VAT for flooring and £199 + VAT for Equipment and the liability to pay the Survey Fee arises on submission of the relevant Request Form. The site Survey Fee will be waived when the Customer places an Order for installation and the Escape Fitness in-house installation team carry out the Survey. Where Customers do not proceed with the installation for whatever reason, the site Survey Fee shall be invoiced and payable in accordance with clause 2.2 above.
- 4.2 All designs created in respect of any installation are subject to clause 11 below so that the Customer may not use such designs or any designs that the Supplier believes breach the Supplier's Intellectual Property Rights unless a separate contract for the purchase of a licence to use the designs is negotiated and entered into. This clause 4.2 shall survive termination of the Contract howsoever determined.
- 4.3 To the extent that any element or component of the Goods (e.g. line markings, bench upholstery) are to be manufactured in accordance with colour and/or design specifications supplied by the Customer, the Customer shall indemnify the Supplier against all liabilities, costs, expenses, damages and losses (including any direct, indirect or consequential losses) suffered or incurred by the Supplier in connection with any claim made against the Supplier for actual or alleged infringement of a third party's intellectual property rights arising out of or in connection with the Supplier's use of that component. This clause 4.3 shall survive termination of the Contract howsoever determined.
- 4.4 The Supplier reserves the right to amend the Specification of the Goods if required so to do by the manufacturer or any applicable statutory or regulatory body.
- 4.5 Where Contracts involve installation and the Customer's installation area does not comply strictly with the Working Conditions Specification ("Specification") detailed in the Programme of Works, the installation shall be delayed until such time as the Customer is compliant with the Specification and the Customer shall be liable to the Supplier for all costs and expenses incurred by the delay. Without prejudice to the generality of this clause; time when appointed contractors are unable to perform the Contract ("Downtime") shall be payable to the Supplier at the rate of £200.00 per man per day (based on an 8 hour day) plus full reimbursement of all travel, accommodation and other expenses properly incurred in anticipation of performance of the Contract and which cannot otherwise be recouped from the relevant provider by the Supplier (Wasted Costs).

5. CARRIAGE.

Carriage is payable by the Customer in respect of each Order. Carriage charges are unaffected by the number of instalments in which the Goods are delivered.

6. DELIVERY.

- 6.1 Delivery lead times vary according to the Goods Ordered. If Goods will not be delivered on the "Estimated Delivery Date" detailed on the Order Confirmation, the Customer will be advised of the intended delivery date as soon thereafter as reasonably practical. Any date quoted for delivery of the Goods is approximate only and time of delivery is not of the essence. The Supplier shall not be liable for any delay in delivery of the Goods that is caused by events beyond its control nor the Customer's failure to provide the Supplier with adequate delivery instructions or any other instructions that are relevant to the supply of the Goods.
- 6.2 Customised, bespoke and special order Goods have varying manufacturing lead times (provided by the manufacturer as at the date of the Supplier's Order) which will be notified to the Customer as the Estimated Delivery Date. It will take up to a further 7 days for the Goods to be delivered to the Customer once the Goods are delivered to the Supplier. It is the Customer's responsibility to ensure any planned installation date takes account of these times. A firm delivery date will be notified to the Customer once the Goods are under the care and control of the Supplier.
- 6.3 Delivery of the Goods shall be completed once the Goods arrive at the exterior access point of the delivery address. The Customer's signature recorded on the Delivery Note (or similar device operated by the carrier) shall be conclusive evidence of the quantities dispatched and delivered."
- 6.4 It is the responsibility of the Customer to ensure that appropriate arrangements are in place to:
- accept delivery of the Goods on the Delivery date; and
 - where there are large/heavy Goods; provide adequate manpower to unload the Goods from the pallet(s) upon delivery and dispose of any transit packaging supplied; and (c) for Orders involving installation; arrange to store the Goods pending installation in climatic conditions that will emulate the climate of the area in which the flooring or equipment will be installed and in accordance with the storage instructions (if any) supplied upon delivery.
- 6.5 If the Customer fails to accept or take delivery of the Goods in accordance with clause 6.4 above, then, save where such failure or delay is caused by a Force Majeure Event or by the Supplier's failure to comply with its obligations under this Contract, delivery of the Goods shall be deemed to have been completed at 9.00 am on the day after the Delivery Date notified by the Supplier. The Supplier shall store the Goods until actual delivery takes place, and charge the Customer for all related costs and expenses (including insurance) incurred in this respect. A Force Majeure Event means an event beyond the control of a party (or any person acting on its behalf), which by its nature could not have been foreseen by such party (or such person), or, if it could have been foreseen, was unavoidable, and includes, without limitation, acts of God, storms, floods, riots, fires, sabotage, civil commotion or civil unrest, interference by civil or military authorities, acts of war (declared or undeclared) or armed hostilities or other national or international calamity or one or more acts of terrorism or failure of energy sources.

7. INSTALLATION.

- 7.1 The Supplier shall install the flooring or equipment in accordance with the Contract.
- 7.2 Where installation is delayed under clause 4.5 above, the Supplier may at its own discretion:
- perform or assist the Customer to perform the work required to make the Customer installation area compliant with the Specification and the Customer shall be liable only for the additional costs associated with such works at the Wasted Costs rates specified in clause 4.5 above; or

- delay the installation in accordance with clause 4.5 above and claim the Wasted Costs thereof; or
 - cancel the installation and refund to the Customer the sum equivalent to 50% of the cost of installation (as per the Quotation), provided always that the Suppliers' Wasted Costs are first paid in full (at the rates quoted in clause 4.5 above). In the event that deduction of the Wasted Costs leaves less than 50% of the cost of installation, then the Supplier shall repay the balancing sum only.
- 7.3 In the event that the Customer changes a confirmed installation date less than 48 hours before the planned start time, the Customer shall be liable for the Supplier's Wasted Costs as detailed in clause 4.5 above.

8. TITLE AND RISK.

- 8.1 The risk in the Goods shall pass to the Customer on completion of the property.
- 8.2 Notwithstanding delivery and the passing of risk pursuant to clause 8.1, property in and title to the Goods shall remain with the Supplier until the Supplier has received payment of:
- the full price of the Goods that are the subject of the Contract; and
 - the full price of all other goods and services provided by the Supplier to the Customer under any other contract. Payment of the full price shall include, without limitation, the amount of any interest or other sum payable under the terms of this and all other contracts between the Supplier and Customer.
- 8.3 Until title passes, the Customer shall:
- store the Goods separately from all other goods held by the Customer so that they remain readily identifiable as the Supplier's property;
 - not remove, deface or obscure any identifying mark or packaging on or relating to the Goods;
 - keep the Goods insured against all risks for their full retail price on the Supplier's behalf from completion of delivery.
 - maintain the Goods in satisfactory condition and keep them insured against all risks for their full price from the date of delivery; and
 - give the Supplier such information as the Supplier may reasonably require from time to time relating to the Goods and the financial position of the Customer
- 8.4 At any time before title to the Goods passes to the Customer, the Supplier may require the Customer to deliver up all goods in its possession that have not been resold and if the Customer fails to do so promptly, enter any premises of the Customer or of any third party where the Goods are sold in order to recover them.

9. CANCELLATIONS, AMENDMENTS AND RETURNS.

- 9.1 Once an Order is placed by the Customer, the Supplier will issue an Order Confirmation. Orders may only be amended or cancelled if:
- the Customer formally notifies the Supplier in writing by email to aftersales@escapefitness.com or Customer Services Department, Escape Fitness Limited, Units 11-14 Tresham Road, Orton Southgate, Peterborough, Cambridgeshire, PE2 6SG; and
 - the notification is received within 14 days of the date of the Order Confirmation; and
 - no Goods have been dispatched.
- A fee of 10% of the Order value (net of VAT) will be charged to cover administration costs in such cases. The Supplier reserves the right to reduce the above fee, in its sole discretion, when the amendment sought by the Customer is "de minimis" or there are other exceptional circumstances justifying the same.
- 9.2 Where Goods have been dispatched, the Customer may return some or all of the Goods within 14 days after delivery (as recorded by the Carrier) provided that the Customer follows the procedure notified by the Customer Services Department who may be

contacted free on 0800 031 5400 or 01733 313535 or in writing at aftersales@escapefitness.com or Customer Services Department, Escape Fitness Limited, Units 11-14 Tresham Road, Orton Southgate, Peterborough, Cambridgeshire, PE2 6SG. The Goods must be returned to the Supplier at the Customer's cost and in a new and unused condition with all original labels and packaging intact. A fee of 20% of the returned Goods value (net of VAT) will be charged to cover administration and stock handling costs. Goods may not be returned unless a returns reference number has been issued by the Supplier's Customer Services Department.

10. DAMAGES AND DELIVERY DISCREPANCIES.

- 10.1 When signing for a delivery, the Customer is accepting that the correct number of parcels has been delivered and the Goods have not been damaged in transit. All deliveries must therefore be checked as soon as received and BEFORE the Delivery Note is signed as any discrepancy in the consignment MUST be notified to Escape Fitness immediately, and within 48 hours at the latest. Please note the time of delivery as recorded on the Delivery Note. If the order is incorrect or damaged, the Customer should either refuse the consignment or record the discrepancy or damage on the Delivery Note. It is the Customer's responsibility to ensure that the actions above are followed BEFORE SIGNING as mistakes cannot be rectified once the Goods have been signed for.
- 10.2 If damage or a discrepancy is identified, the Customer should telephone Escape Fitness's Customer Services Department free on 0800 031 5400 or 01733 313535 with full details of the Goods Ordered and the damage or discrepancy identified. At its sole discretion, the Supplier will either replace or repair the Goods. Reports of damage or discrepancy will not be entertained after the expiration of 48 hours from the time of delivery as recorded on the Delivery Note or similar device operated by the carrier. The Customer should only return Goods following the procedures outlined by the Supplier at the time of the report.

11. INTELLECTUAL PROPERTY RIGHTS.

The Customer acknowledges that all intellectual property rights in the Goods and/or Services (e.g. product design, flooring design, gym design), whether registered or unregistered and including all applications for and renewals or extensions of such rights, and all similar or equivalent rights or forms of protection in any part of the world including all patents, rights to inventions, utility models or prototypes, copyright and related rights, trademarks, service marks, trade, business and domain names, belong to or are used by Supplier under licence. The Customer agrees that it shall not use the same unless a licence to use them has been granted within a contract for the provision of Goods and/or Services to be supplied by the Supplier.

12. PRODUCT DESCRIPTIONS.

The Supplier endeavours to ensure that the product images, descriptions, weights and measurements which appear in any Supplier literature are fair and accurate. The Supplier accepts no responsibility for any error or omissions either to the Customer or at all. The Supplier reserves the right to discontinue or change the specification and/or the design of a product without prior notice. Colour, packaging and product specification may vary according to manufacturing changes, tolerances and availability.

13. WARRANTIES AND LIMITATION OF LIABILITY.

- 13.1 Nothing in these Conditions excludes or limits liability for; (a) death or personal injury caused by the negligence of the Supplier, or (b) fraudulent misrepresentation or any other liability that the Supplier may not otherwise exclude or limit under applicable law.
- 13.2 The Supplier warrants that the Goods supplied to the Customer under this Contract shall be free from defects in materials and workmanship and comply with all applicable statutory and regulatory requirements for not less than the period of the manufacturer's warranty period.

13.3 The Supplier shall not be liable for the Goods' failure to comply with the warranty in clause 13.2 if:

- the Customer makes any further use of such Goods after notifying the Supplier of a defect; or
- the defect has arisen as a result of the Customer's failure to follow the Supplier's oral or written instructions as to the storage or care of the Goods or (if there are none) good trade practice; or
- the defect has arisen as a result of the Supplier following any drawing, design or specification supplied by the Customer; or
- the Customer alters or repairs the Goods without the prior written consent of the Supplier; or
- the defect arises as a result of fair wear and tear, wilful damage, negligence, or the use of the Goods for a purpose other than the purpose declared or in abnormal use conditions; or
- the Goods differ from their description as a result of changes made to ensure they comply with applicable statutory or regulatory standards.

13.4 Except as provided in this clause 13; the Supplier shall have no liability to the Customer in respect of the Goods' failure to comply with the warranty set out in clause 13.2 or otherwise.

13.5 Subject to clause 13.1 above, the Supplier shall not be liable, in contract or tort, (including, without limitation, negligence), for pre-contract or other representations (other than fraudulent misrepresentations) or otherwise arising out of or in connection with the Conditions for any economic losses (including without limitation loss of profit, revenue, contracts, business or anticipated savings); loss of goodwill or reputation or special or indirect losses suffered or incurred by the Customer arising out of or in connection with the provision of the Goods and Services supplied in respect of this Contract.

13.6 Notwithstanding the above and subject to clause 13.1, the Supplier's aggregate liability (whether in contract, tort or otherwise) for loss or damage shall in any event be limited to a sum equal to the amount paid or payable by the Customer for the Goods in respect of one incident or series of incidents attributable to one cause.

14. GENERAL.

- 14.1 These Conditions, including the documents referred to herein, supersede all prior representations, understandings, agreements and contracts between the Customer and the Supplier relating to the supply of Goods and Services and sets forth the entire agreement and understanding between the Customer and the Supplier.
- 14.2 Nothing in this Contract is intended to, or shall be deemed to, constitute a partnership or joint venture of any kind between any of the parties, nor constitute any party the agent of another party for any purpose. No party shall have authority to act as agent for, or to bind, the other party in anyway.
- 14.3 A person who is not a party to the Contract shall not have any rights under or in connection with it.
- 14.4 The Customer may not assign or sub-contract any of the rights or obligations imposed by this Contract unless agreed to in writing by the Supplier.
- 14.5 The Supplier reserves the right to transfer, assign, novate or sub-contract the benefit of the whole or part of any of its rights or obligations under these Conditions or any related contract to any third party.
- 14.6 No delay or failure by the Supplier to exercise any powers, rights or remedies under this Contract will operate as a waiver of them nor will any single or partial exercise of any such powers, rights or remedies preclude any other or any further exercise of them. To take effect any waiver must be in writing and signed by an authorised signatory of the Supplier.
- 14.7 This Contract, and any dispute or claim arising out of or in connection with it or its subject matter or formation (including non-contractual disputes or claims), shall be governed by, and construed in accordance with, English law, and the parties irrevocably submit to the exclusive jurisdiction of the courts of England and Wales.

GENERAL WARRANTY INFORMATION.

All Escape Fitness products are warranted to be free from defects in materials and workmanship. This warranty is non transferrable and extends only to the original Customer. The products are additionally warranted to comply with all applicable statutory and regulatory requirements. The warranty commences on the date of delivery to the Customer (as recorded by the carrier), and subject to the Exclusions section herein, is valid for not less than the period stated in the full product warranty schedule found at www.escapefitness.com.

Each Escape Fitness product is designed for a specific purpose. Products should only be used for their intended purpose, in an area designed or suitable for that product's use and by users aged 16 years or older.

Products which are not stored, cared for or used as directed or in normal use conditions may fail. Failure in these circumstances is considered abuse and will be excluded from a warranty claim even where the failure occurs during the stated warranty period.

EXCLUSIONS.

Escape Fitness shall have no liability under the warranty if:

- any further use of the product(s) is made after a defect has been notified. Faulty products should be removed from service until the claim is resolved; or
- the defect has arisen as a result of a failure to properly use, store, care for or maintain the products; or
- the defect has arisen as a result of Escape Fitness following any drawing, design or specification supplied or specifically requested by you; or
- the product(s) is altered or repaired without the prior written consent of Escape Fitness; or
- the defect arises as a result of fair wear and tear, corrosion due to incorrect storage, wilful or negligent damage or the use of the products for a purpose other than the purpose intended or in abnormal use conditions; or
- the products differ from their description as a result of changes made to ensure they comply with applicable statutory or regulatory standards.

Escape Fitness shall not be liable, in contract or tort, (including, without limitation, negligence), for pre-contract or other representations (other than fraudulent misrepresentations) or otherwise arising out of or in connection with a claim for any economic losses (including without limitation loss of profit, revenue, contracts, business or anticipated savings); loss of goodwill or reputation or special or indirect losses suffered or incurred and arising out of or in connection with the provision of the products. Escape Fitness's aggregate liability (whether in contract, tort or otherwise) for loss or damage shall in any event be limited to a sum equal to the amount paid or payable for the product(s) in respect of one incident or series of incidents attributable to one cause.

MAKING A CLAIM.

A warranty claim will only be accepted when the following procedure is used. Once a claim has been determined, Escape Fitness will, at its sole discretion, either repair/replace the product or issue a credit note or refund. Where the claim is found to be unsubstantiated, Escape Fitness will reject the claim (and where appropriate) return the product to you.

CLAIMS PROCEDURE.

- If the product was purchased through an Escape Fitness approved Distributor, please refer the claim to the Distributor will deal with the claim directly.
- If the product was purchased directly from Escape Fitness, please telephone the Customer Services Department on 01733 313 535 or email aftersales@escapefitness.com quoting the Order Number of the product and provide full details of how and when the product(s) has been used, the fault or damage identified and the contact details of the person dealing with the claim. Escape Fitness will log the claim and allocate a unique "X" reference which needs to be quoted in all future dealings with the claim.
- Photographic evidence in support of the claim should be sent by email or post which should clearly identify the damage/defect. Within 48 hours of receipt of a properly evidenced claim, the quality control department will report their findings and advise whether the claim is accepted or rejected. If accepted, Escape Fitness will advise whether the product will be repaired or replaced, or if a credit or refund will be made and whether or not the product(s) needs to be returned for a full quality control investigation which will be arranged and paid for by Escape Fitness.
- After your claim has been processed we will contact you again to ensure that your claim was satisfactorily resolved.

Please refer to www.escapefitness.com/uk/warranties for full product warranty schedule.

ESCAPE YOUR LIMITS.

ESCAPE FITNESS LTD HEAD OFFICE.

11-14 Tresham Road, Orton Southgate,
Peterborough, Cambridgeshire,
PE2 6SG, England

TELEPHONE +44(0)1733 313 535

FACSIMILE +44(0)1733 316 539

EMAIL sales@escapefitness.com

WEBSITE www.escapefitness.com

Registered in England 4215703

ESCAPE FITNESS USA LLC.

4434 Muhlhauser Road, Suite 300,
Westchester, OH 45011, USA

TELEPHONE +1 614 706 4462

EMAIL salesusa@escapefitness.com

WEBSITE www.escapefitness.com/us

Registered in USA 201206600158

ESCAPE FITNESS POLAND SP. Z O.O.

TELEPHONE +48(0)59 8634 322

EMAIL poland@escapefitness.com

WEBSITE www.escapefitness.com/pl

Registered in Poland 0000244786

© **ESCAPE FITNESS LIMITED 2024.**